

KENWOOD

DVD / VCD / CD PLAYER

DV-203

INSTRUCTION MANUAL

KENWOOD CORPORATION

This player has been designed to play back the DVD software which has been encoded for specific region areas. It cannot play back the DVD software encoded for other region areas than the region areas for which it has been designed.



Introduction

DV-203 (En/K)

2 Before applying power

⚠ Caution : Read this section carefully to ensure safe operation.

Units are designed for operation as follows.





This unit is intended for AC 110-240 V
(U.S.A. and Canada AC 120 V only)

Preparations

Safety precautions

⚠ Caution : Read this section carefully to ensure safe operation.

WARNING : TO PREVENT FIRE OR ELECTRIC SHOCK, DO NOT EXPOSE THIS APPLIANCE TO RAIN OR MOISTURE.

	CAUTION RISK OF ELECTRIC SHOCK DO NOT OPEN		CAUTION: TO REDUCE THE RISK OF ELECTRIC SHOCK, DO NOT REMOVE COVER (OR BACK). NO USER-SERVICEABLE PARTS INSIDE. REFER SERVICING TO QUALIFIED SERVICE PERSONNEL.
	THE LIGHTNING FLASH WITH ARROWHEAD SYMBOL, WITHIN AN EQUILATERAL TRIANGLE, IS INTENDED TO ALERT THE USER TO THE PRESENCE OF UNINSULATED "DANGEROUS VOLTAGE" WITHIN THE PRODUCT'S ENCLOSURE THAT MAY BE OF SUFFICIENT MAGNITUDE TO CONSTITUTE A RISK OF ELECTRIC SHOCK TO PERSONS.		
	THE EXCLAMATION POINT WITHIN AN EQUILATERAL TRIANGLE IS INTENDED TO ALERT THE USER TO THE PRESENCE OF IMPORTANT OPERATING AND MAINTENANCE (SERVICING) INSTRUCTIONS IN THE LITERATURE ACCOMPANYING THE APPLIANCE.		

The marking of products using lasers (Except for some areas)

**CLASS 1
LASER PRODUCT**

The marking is located on the rear panel and says that the component uses laser beams that have been classified as Class 1. It means that the unit is utilizing laser beams that are of a weaker class. There is no danger of hazardous radiation outside the unit.

Unpacking

Unpack the unit carefully and make sure that all accessories are put aside so they will not be lost.

Examine the unit for any possibility of shipping damage. If your unit is damaged or fails to operate, notify your dealer immediately. If your unit was shipped to you directly, notify the shipping company without delay. Only the consignee (the person or company receiving the unit) can file a claim against the carrier for shipping damage.

We recommend that you retain the original carton and packing materials for use should you transport or ship the unit in the future.

Keep this manual handy for future reference.

Accessories

Audio cord (Red, White) (1)



Video cord (Yellow) (1)



Optical fiber cable (1)



Remote control unit (1)

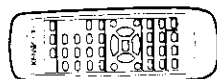

Batteries (R6/AA) (2)



For the U.S.A.

FCC WARNING

This equipment may generate or use radio frequency energy. Changes or modifications to this equipment may cause harmful interference unless the modifications are expressly approved in the instruction manual. The user could lose the authority to operate this equipment if an unauthorized change or modification is made.

NOTE:

This equipment has been tested and found to comply with the limits for a Class B digital device, pursuant to Part 15 of the FCC Rules. These limits are designed to provide reasonable protection against harmful interference in a residential installation. This equipment may cause harmful interference to radio communications, if it is not installed and used in accordance with the instructions. However, there is no guarantee that interference will not occur in a particular installation. If this equipment does cause harmful interference to radio or television reception, which can be determined by turning the equipment off and on, the user is encouraged to try to correct the interference by one or more of the following measures:

- Reorient or relocate the receiving antenna.
- Increase the separation between the equipment and receiver.
- Connect the equipment into an outlet on a circuit different from that to which the receiver is connected.
- Consult the dealer or an experienced radio/TV technician for help.

For the U.S.A.

CAUTION:

Use of controls or adjustment or performance of procedures other than those specified herein may result in hazardous radiation exposure.

In compliance with Federal Regulations, following are reproductions of labels on, or inside the product relating to laser product safety.

KENWOOD CORPORATIN
2967-3, ISHIKAWA-CHO, HACHIOJI-SHI,
TOKYO, JAPAN

KENWOOD CORP. CERTIFIES THIS EQUIPMENT
CONFORMS TO DHHS REGULATIONS NO. 21
CFR 1040.10, CHAPTER I, SUBCHAPTER J.

Location: Back Panel

CAUTION-LASER RADIATION WHEN OPEN.
DO NOT STARE INTO BEAM.

Location: Laser Pick-up Unit Cover inside this product

IMPORTANT SAFEGUARDS

DV-203 (En/K)

⚠ Caution : Read this page carefully to ensure safe operation.

Please read all of the safety and operating instructions before operating this appliance. Adhere to all warnings on the appliance and in the instruction manual. Follow all the safety and operating instructions. These safety and operating instructions should be retained for future reference.

- 1. Power sources** – The appliance should be connected to a power supply only of the type described in the instruction manual or as marked on the appliance. If you are not sure of the type of power supply to your home, consult your appliance dealer or local power company. For appliances intended to operate from battery power, or other sources, refer to the instruction manual.
- 2. Power-cord protection** – Power-supply cords should be routed so that they are not likely to be walked on or pinched by items placed upon or against them, pay particular attention to cords at plugs, convenience receptacles, and the point where they exit from the appliance.

Never pull or stretch the cord.



- 3. CAUTION – Polarization** – This appliance may be equipped with a polarized alternating-current line plug (a plug having one blade wider than the other). This plug will fit into the power outlet only one way. This is a safety feature. If you are unable to insert the plug fully into the outlet, try reversing the plug. If the plug should still fail to fit, contact your electrician to replace your obsolete outlet. Do not defeat the safety purpose of the polarized plug.
- 4. Ventilation** – Slots and openings in the cabinet are provided for ventilation and to ensure reliable operation of the appliance and to protect it from overheating, and these openings must not be blocked or covered. The appliance should be situated so that its location or position does not interfere with its proper ventilation.
To maintain good ventilation, do not put records or a tablecloth on the appliance. Place the appliance at least 10 cm away from the walls.
Do not use the appliance on a bed, sofa, rug or similar surface that may block the ventilation openings. This appliance should not be placed in a built-in installation such as a bookcase or rack unless proper ventilation is provided or the manufacturer's instructions have been adhered to.

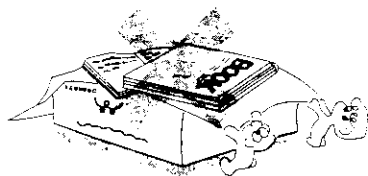

- 5. Water and moisture** – The appliance should not be used near water - for example, near a bathtub, washbowl, kitchen sink, laundry tub, in a wet basement, or near a swimming pool, etc.

- 6. Temperature** – The appliance may not function properly if used at extremely low, or freezing temperatures. The ideal ambient temperature is above +5°C (41°F).
- 7. Heat** – The appliance should be situated away from heat sources such as radiators, heat registers, stoves, or other appliances (including amplifiers) that produce heat.
- 8. Electric shock** – Care should be taken so that objects do not fall and liquid is not spilled into the enclosure through openings. If a metal object, such as a hair pin or a needle, comes into contact with the inside of this appliance, a dangerous electric shock may result. For families with children, never permit children to put anything, especially metal, inside this appliance.

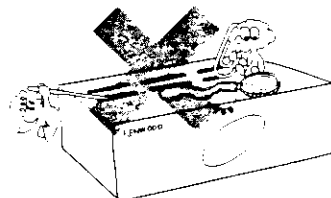

- 9. Enclosure removal** – Never remove the enclosure. If the internal parts are touched accidentally, a serious electric shock might occur.

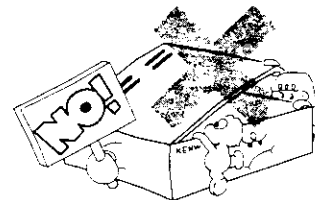

- 10. Magnetic fields** – Keep the appliance away from sources of magnetic fields such as TV sets, speaker systems, radios, motorized toys or magnetized objects.
- 11. Cleaning** – Unplug this appliance from the wall outlet before cleaning. Do not use volatile solvents such as alcohol, paint thinner, gasoline, or benzene, etc. to clean the cabinet. Use a clean dry cloth.
- 12. Accessories** – Do not place this appliance on an unstable cart, stand, tripod, bracket, or table. The appliance may fall, causing serious injury to a child or adult, and serious damage to the appliance. Use only with a cart, stand, tripod, bracket, or table recommended by the manufacturer, or sold with the appliance. Any mounting of the appliance should follow the manufacturer's instructions, and should use a mounting accessory recommended by the manufacturer. An appliance and cart combination should be moved with care. Quick stops, excessive force, and uneven surfaces may cause the appliance and cart combination to overturn.



13. Lightning – For added protection for this appliance during a lightning storm, or when it is left unattended and unused for long periods of time, unplug it from the wall outlet and disconnect the antenna or cable system. This will prevent damage to the appliance due to lightning and power-line surges.

14. Abnormal smell – If an abnormal smell or smoke is detected, immediately turn the power OFF and unplug the appliance from the wall outlet. Contact your dealer or nearest service center.

POWER OFF!

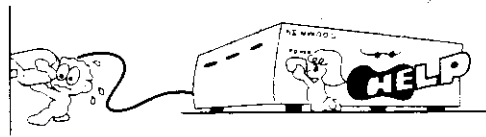

15. Damage requiring service – The appliance should be serviced by qualified service personnel when:

- A. The power-supply cord or the plug has been damaged.
- B. Objects have fallen, or liquid has been spilled into the appliance.
- C. The appliance has been exposed to rain or water.
- D. The appliance does not appear to operate normally by following the instruction manual. Adjust only those controls that are covered by the instruction manual as an improper adjustment of other controls may result in damage and will often require extensive work by a qualified technician to restore the appliance to its normal operation.
- E. The appliance has been dropped, or the enclosure damaged.
- F. The appliance exhibits a marked change in performance.

16. Servicing – The user should not attempt to service the appliance beyond that described in the instruction manual. All other servicing should be referred to qualified service personnel.

17. Outdoor antenna grounding – If an outside antenna is connected to the appliance, be sure the antenna system is grounded so as to provide some protection against voltage surges and built up static charges. Article 810 of the National Electrical Code – ANSI/NFPA 70, provides information with respect to proper grounding of the mast and supporting structure, grounding of the lead-in wire to an antenna discharge unit, size of grounding conductors, location of antenna discharge unit, connection to grounding electrodes, and requirements for the grounding electrode. See Figure.

18. Power lines – An outside antenna system should not be located in the vicinity of overhead power lines or other electric light or power circuits, or where it can fall into such power lines or circuits. When installing an outside antenna system, extreme care should be taken to keep from touching such power lines or circuits as contact with them might be fatal.

19. AC outlets – Do not connect other audio equipment with a power consumption larger than that specified to the AC outlet on the rear panel. Never connect other electrical appliances, such as an iron or toaster, to it to prevent fire or electric shock.

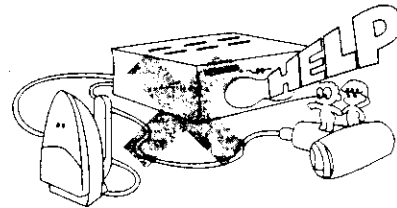

20. Overloading – Do not overload wall outlets, extension cords, or integral convenience receptacles as this can result in a risk of fire or electric shock.

21. Attachment – Do not use attachments not recommended by the appliance manufacturer as they may cause hazards.

22. Replacement parts – When replacement parts are required, be sure the service technician has used replacement parts specified by the manufacturer or have the same characteristics as the original parts. Unauthorized substitutions may result in fire, electric shock, or other hazards.

23. Safety check – Upon completion of any service or repairs to this appliance, ask the service technician to perform safety checks to determine that the appliance is in proper operating condition.

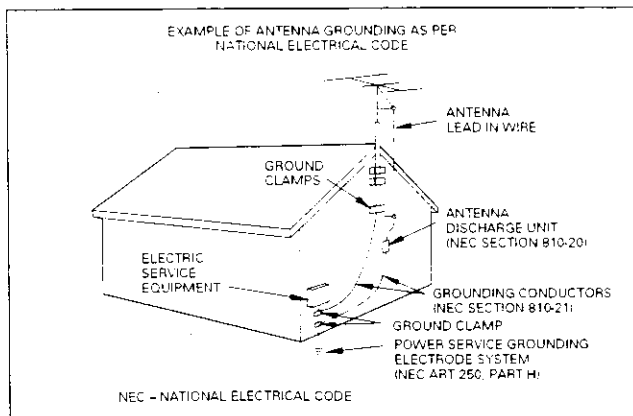





1. Item 3 is not required except for grounded or polarized equipment.
2. Item 17 and 18 are not required except for units provided with antenna terminals.
3. Item 17 complies with UL in the U.S.A.

Preparations

Caution : Read the pages marked  carefully to ensure safe operation.

Preparations

Operations

Introduction	2
 Before applying power	2
 Safety precautions	2
Accessories	3
 IMPORTANT SAFEGUARDS	4
Contents	6
Special features	8
Region codes	9
Region codes of this player	9
Region codes of the DVD discs that can be played with this player	9
Region codes in the world	10
Restrictions due to difference between discs	10
Playable Disc	11
Recording systems and types of playable discs	11
Unplayable discs	11
Icons on the DVD discs	11
Video formats	12
Video formats of DVD discs that can be played on this unit	12
Video formats of VCD discs that can be played on this unit	13
Examples of TV screen display of each video format	13
Important items	14
Maintenance	14
Reference	14
 System Connections	15
Connection with TV with S-VIDEO jacks and general stereo system	15
Connection with an AV receiver	16
Controls and indicators	19
Display / Main unit	19
Remote control unit	20
Operation of remote control unit	21
Loading batteries	21
Operation	21
Basic operation of cursor keys	21
Playback	22
Playing a disc from the beginning	22
Forward search and reverse search (Manual search)	24
Skipping tracks or chapters	24
Frame-by-frame playback	24
Slow playback	24
Playing tracks in a random order (Random playback)	25
Letting playback pause	25
Stopping playback	25
DISPLAY key	25
Operations using the GUI screen	26
Basic operations on the GUI screen	26
Icons on the TV screen	27
Storing scenes in memory (Memory function)	29
Storing a scene in memory	29
Recalling/clearing a scene in memory	29
Programming	30
Programming tracks in the desired order	30
Adding tracks (chapters) in the program	31
Clearing tracks (chapters) from the program	31
Returning to normal playback	31

Operations

Repeating tracks, chapters or titles (Repeat playback, A-B repeat)	32
Repeating a single track (chapter or title) (Repeat playback)	32
Repeating entire disc (Repeat playback)	32
Repeating a desired section (A-B repeat)	33
Repeating program playback (Program repeat)	33
Versatile DVD play features	34
Switching the voice language (Multi-audio function)	34
Displaying/switching the subtitle language (Multi-subtitle function)	35
To switch the viewing angle (Angle function)	36
Menu playback	37
Hierarchical structure of VCD menus	37
Playback without using the menu playback function	37
Menu playback (DVD)	38
Title selection using the title menu (Title function)	39
Enjoying Virtual Surround sound (VIRTUAL SURR.)	40
Changing the initial setup	41
Basic operation for changing the initial setup	41
Changing initial setup [1 Disc Languages]	42
Changing initial setup [2 Ratings]	43
Changing initial setup [3 Menu Language]	45
Changing initial setup [4 On-Screen Messages]	45
Changing initial setup [5 FL Display]	46
Changing initial setup [6 TV Aspect]	47
Changing initial setup [7 Digital Audio Output]	48
Changing initial setup [9 Other Settings]	50
DVD menu language code list	51
CD-TEXT operation	52
Searching for tracks by title (TITLE SEARCH)	52
Selecting the text information display (TEXT DISPLAY)	53
Displaying all the text information (ALL INFO.)	53
Graphical remote control unit (GRC unit)	54
Basic operation of the DVD player	54
Glossary	55
In case of difficulty	56
Specifications	58

Operations

Other

Special features

DV-203 (En/K)

This document classifies the applications of each feature using the following symbols.



Description of a feature that can be used with DVD.



Description of a feature that can be used with VIDEO CD.



Description of a feature that can be used with CD.

Higher video quality than S-VHS video and LaserDisc



The horizontal resolution of 500 lines or more is far above that of the S-VHS video (400 lines) and LaserDisc (430 lines). The picture quality is more noticeable when the screen size is larger.

Higher audio quality than music CD



The ultrahigh audio quality design can play discs with higher quality than CDs, such as a recording with 48 kHz sampling frequency and 16-bit quantization up to 96 kHz sampling frequency and 24-bit quantization. A recording with the 96 kHz sampling frequency can reproduce as high frequencies as above 40 kHz!

Graphical user interface (GUI) compatibility



The information related to the player and disc can be displayed on the TV screen by pressing the ON SCREEN key of the remote control unit. The remote control unit also has cursor keys for simple operations and settings of the player.

Built-in Dolby Digital (AC-3) decoder





A Dolby Digital (AC-3) decoder is built in to bring movie theater-class powerfulness and presence to home theaters.

Versatile DVD playback features



Multi-audio function: - 34
 Icons on a DVD disc means that the spoken voice language can be selected from up to 8 languages. (The number of available voice languages is variable depending on discs.)

Multi-subtitle function: - 35
 Icons on a DVD disc means that the subtitle language can be selected from up to 32 languages. (The number of available subtitle languages is variable depending on discs.)

Angle function: - 36
 Icons on a DVD disc means that some objects can be viewed from up to 9 different camera angles, as if switching the video shot with multiple cameras. (The number of available angles is variable depending on discs.)

Ratings function: - 43
When a DVD disc contains scenes that should be protected from viewing of children, playback of such scenes can be prohibited based on the assigned restriction levels. (This feature is available only with discs containing the recording of viewing restriction levels.)

CD-TEXT compatibility



Text information recorded in CD (disc title, track titles, musician names, verse writer names, composer names, etc.) can be recalled and displayed in alphanumeric characters. (Certain character types may not be able to be displayed.)

DTS digital output compatibility



Digital data can be output from DTS-encoded discs.

Region codes

DV-203 [En/K]

Region codes of this player

Every player of this model has a certain region code assigned to it based on the country where the player is used. When the player is used to play back DVD discs, it can only play the DVD discs carrying the region codes matching the region code of the player. See the following table for details. (The table shows the data as of October 1997.)

Region Code of Player	Usable Country or Area
1	Canada, United States, American Samoa, Bermuda, Johnston Island, Midway Islands, Puerto Rico, St. Pierre and Miquelon, United States Virgin, Wake Island
2	Albania, Andorra, Austria, Bahrain, Belgium, Bosnia and Herzegovina, Bulgaria, Croatia, Cyprus, Czech, Denmark, Egypt, Finland, France, Germany, Greece, Hungary, Iceland, Iran, Iraq, Ireland, Israel, Italy, Japan, Jordan, Kuwait, Lebanon, Lesotho, Liechtenstein, Luxembourg, Macedonia, Malta, Monaco, Netherlands, Norway, Oman, Poland, Portugal, Qatar, Romania, San Marino, Saudi Arabia, Slovakia, Slovenia, South Africa, Spain, Swaziland, Sweden, Switzerland, Syrian Arab Republic, Turkey, United Arab Emirates, United Kingdom, Vatican City State, Yemen, Yugoslavia, Channel Islands, Faeroe Islands, Gibraltar, Greenland, Isle of Man, Svalbard and Jan Mayen Islands
3	Brunei Darussalam, Cambodia, Indonesia, Korea, Laos, Malaysia, Myanmar, Philippines, Singapore, Thailand, Viet Nam, East Timor, Hong Kong, Macau, Taiwan
4	Antigua and Barbuda, Argentina, Australia, Bahamas, Barbados, Belize, Bolivia, Brazil, Chile, Colombia, Costa Rica, Cuba, Dominica, Dominican Republic, Ecuador, El Salvador, Fiji, Grenada, Guatemala, Guyana, Haiti, Honduras, Jamaica, Kiribati, Marshall Islands, Mexico, Micronesia, Nauru, New Zealand, Nicaragua, Palau, Panama, Papua New Guinea, Paraguay, Peru, Saint Christopher and Nevis, Saint Lucia, Saint Vincent and the Grenadines, Samoa, Solomon Islands, Suriname, Tonga, Trinidad and Tobago, Tuvalu, Uruguay, Vanuatu, Venezuela, Anguilla, British Virgin Islands, Cayman Islands, Christmas Island, Cocos Islands, Cook Islands, Falkland Islands, French Guiana, French Polynesia, Guadeloupe, Guam, Martinique, Montserrat, Netherlands Antilles, New Caledonia, Niue, Norfolk Island, Northern Mariana Islands, Pitcairn, Tokelau, Turks and Caicos Islands, Wallis and Futuna Islands
5	Afghanistan, Algeria, Angola, Armenia, Azerbaijan, Bangladesh, Belarus, Benin, Bhutan, Botswana, Burkina Faso, Burundi, Cameroon, Cape Verde, Central Africa, Chad, Comoros, Congo, Cote d'Ivoire, Djibouti, Equatorial Guinea, Eritrea, Estonia, Ethiopia, Gabon, Gambia, Georgia, Ghana, Guinea, Guinea-Bissau, India, Kazakhstan, Kenya, Kyrgyz Republic, Latvia, Liberia, Libya, Lithuania, Madagascar, Malawi, Maldives, Mali, Mauritania, Mauritius, Moldova, Mongolia, Morocco, Mozambique, Namibia, Nepal, Niger, Nigeria, North Korea, Pakistan, Russia, Rwanda, Sao Tome and Principe, Senegal, Seychelles, Sierra Leone, Somalia, Sri Lanka, Sudan, Tadjikistan, Tanzania, Togo, Tunisia, Turkmenistan, Uganda, Ukraine, Uzbekistan, Zaire, Zambia, Zimbabwe, British Indian Territory, Jammu and Kashmir, Mayotte, Reunion, St. Helena ex. dep., Western Sahara
6	China

Region codes of the DVD discs that can be played with this player

This player can play back a DVD disc which carries the corresponding code to the region code of the player shown in the table above, a marking containing the region code of the player or the "ALL" marking shown below. Even when a DVD disc does not carry any indication of the region code, it may sometimes be unable to be played on this player due to certain restrictions.

ALL

10 Region codes in the world

The DVD players are given a region code according to the country or area it is marketed, as shown in the following map.

Préparations

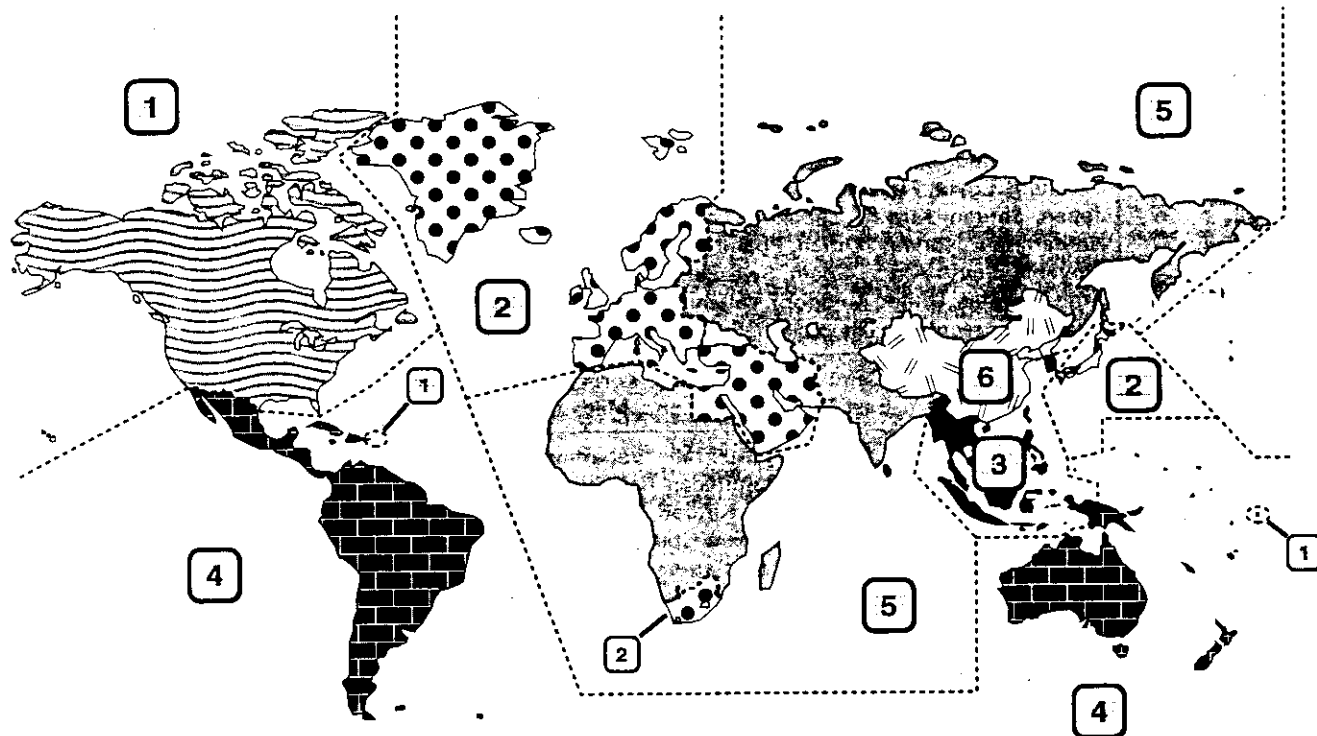

Restrictions due to difference between discs

Some DVD and VCD discs can be played only in certain playback modes according to the intentions of the software producers. As this player plays discs according to their intentions, some functions may not work as intended by you. Please be sure to read the instructions provided with each disc. When an inhibition icon is displayed on the TV screen connected to the player, it indicates that the disc being played is under the restriction as described above.

Inhibition icon



Recording systems and types of playable discs

The system using this unit does not only play music from CD but can also play the discs listed below to offer you high-quality entertainment of video of movies and live concerts.

Playable Disc		DVD		CD		VCD
Logo mark on disc						
Disc size		 8cm	 12cm	 8cm	 12cm	 12cm
Played sides		One or both	One or both	One side only	One side only	One side only
Contents	Video + Audio	Approx. 41 min. (1 side, 1 layer) Approx. 75 min. (1 side, 2 layers) Approx. 82 min. (2 sides, 1 layer) Approx. 150 min. (2 sides, 2 layers)	Approx. 133 min. (1 side, 1 layer) Approx. 242 min. (1 side, 2 layers) Approx. 266 min. (2 sides, 1 layer) Approx. 484 min. (2 sides, 2 layers)	/		Max. 74 min.
	Audio	/		Max. 20 min., digital	Max. 74 min., digital	/

Unplayable discs

This player cannot play back any of the following discs.

- DVD discs recorded by PAL system
- DVD-ROM discs
- DVD-R/DVD-RAM discs
- CD-ROM discs
- VSD discs
- CDV discs (Only the audio part can be reproduced.)
- CD-G/CD-EG/CD-EXTRA discs (Only the audio can be reproduced.)
- CD-R/CD-RW discs (Never attempt to play them.)
- Photo CD discs (Never attempt to play them.)

Icons on the DVD discs

Icon	Description
	Indicates the region code where the disc can be played.
	Number of voice languages recorded with the audio function. The number in the icon indicates the number of voice languages. (Max. 8 languages!)
	Number of subtitle languages recorded with the subtitle function. The number in the icon indicates the number of subtitle languages. (Max. 32 languages!)
	Number of angles provided by the angle function. The number in the icon indicates the number of angles. (Max. 9 angles)
	Aspect ratios that can be selected. "LB" stands for Letter Box and "PS" for Pan/Scan. In the example on the left, the 16:9 video can be converted into letter box video.



See "Glossary" for detailed description on the terms such as aspect ratio, letter box and pan/scan.

Video formats

DV-203 (E)/K

The video signals used to display TV pictures and video disc pictures are mainly based on two types of signal formats (PAL and NTSC), which are assigned to each country or area as shown on the right. As a result, it is required to select discs according to the video format used with your TV monitor (in your country or area).

TV formats of major countries

TV Format	Major Countries & Areas
NTSC	Japan, Taiwan, Korea, U.S.A., Canada, Mexico, Philippines, Chile, etc.
PAL	China, North Korea, U.K., Germany, Australia, New Zealand, Kuwait, Singapore, etc.

Video formats of DVD discs that can be played on this unit

Set the video formats of the DVD discs to be played on this unit as described below.

1 Check the video format(s) used by your TV monitor.

- Refer to the operating instructions of your TV monitor for details.

2 Select DVD discs recorded with the playable video format by referring to the following table.

- See the region code table on the bottom of this page for details on districts 1 to 6.

Your TV format	Playable Disc Formats								
	District 1	District 2-1	District 2-2	District 2-3	District 3	District 4-1	District 4-2	District 5	District 6
NTSC only	NTSC	NTSC* PAL*	NTSC	NTSC PAL*	NTSC PAL*	NTSC* PAL*	NTSC	NTSC* PAL*	NTSC PAL*
PAL only	NTSC*	NTSC PAL	NTSC*	NTSC* PAL	NTSC* PAL	NTSC PAL	NTSC*	NTSC PAL	NTSC* PAL
NTSC/PAL switchable	NTSC	NTSC PAL	NTSC	NTSC PAL	NTSC PAL	NTSC PAL	NTSC	NTSC PAL	NTSC PAL



Normal video may not be reproduced when a disc recorded with the video format marked * in the above table is played. See "Examples of TV screen display of each video format" for details.

3 When your TV is switchable between NTSC and PAL,

- Districts 1, 2-2 and 4-2: Set the TV to NTSC.
- Districts 2-1, 4-1 and 5: Set the TV to PAL.
- Districts 2-3, 3 and 6: Set the TV according to each disc to be played.

4 Now play the disc.

Region code table

	District 1	District 2-1	District 2-2	District 2-3	District 3	District 4-1	District 4-2	District 5	District 6
Area or Country Name, Region Code	North America 1	Europe 2	Japan 2	Middle East 2	Southeast Asia 3	Oceania 4	South America 4	Russia 5	China 6

Video formats of VCD discs that can be played on this unit

Set the video formats of the VCD discs to be played on this unit as described below.

1 Check the video format(s) used by your TV monitor.

- Refer to the operating instructions of your TV monitor for details.

2 Select VCD discs recorded with the playable video format by referring to the following table.

- See the region code table on the bottom of the previous page for details on districts 1 to 6.

Your TV format	Playable Disc Formats								
	District 1	District 2-1	District 2-2	District 2-3	District 3	District 4-1	District 4-2	District 5	District 6
NTSC only	NTSC PAL	NTSC* PAL*	NTSC PAL	NTSC PAL*	NTSC PAL*	NTSC* PAL*	NTSC PAL	NTSC* PAL*	NTSC PAL*
PAL only	NTSC* PAL*	NTSC PAL	NTSC* PAL*	NTSC* PAL	NTSC* PAL	NTSC PAL	NTSC* PAL*	NTSC PAL	NTSC* PAL
NTSC/PAL switchable	NTSC PAL	NTSC PAL	NTSC PAL	NTSC PAL	NTSC PAL	NTSC PAL	NTSC PAL	NTSC PAL	NTSC PAL



Normal video may not be reproduced when a disc recorded with the video format marked * in the above table is played. See "Examples of TV screen display of each video format" for details.

3 When your TV is switchable between NTSC and PAL,

- Districts 1, 2-2 and 4-2: Set the TV to NTSC.
- Districts 2-1, 4-1 and 5: Set the TV to PAL.
- Districts 2-3, 3 and 6: Set the TV according to each disc to be played.

4 Now play the disc.

Examples of TV screen display of each video format

When your TV is switchable between PAL/NTSC

Try play a disc. If the picture is black and white or as shown on the right, stop playback and switch the screen display formats of this unit and the TV to another format. This will improve the played picture quality.

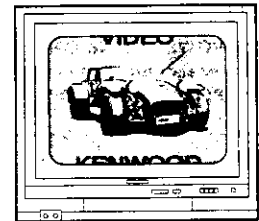
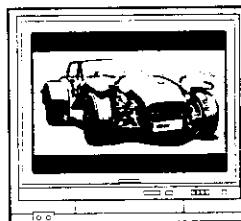

When your TV is compatible only with the PAL format

With certain discs, the playback picture may have black spaces above and below it (as shown on the right). This is because the disc has been recorded in the NTSC format. The screen may be somewhat hard to see but this is not malfunction.

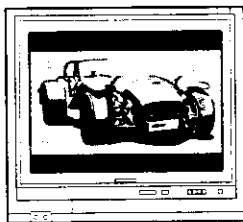

When your TV is compatible only with the NTSC format

With certain discs, the playback picture may be cut above and below it (as shown on the right). This is because the disc has been recorded in the PAL format. The screen may be somewhat hard to see but this is not malfunction.

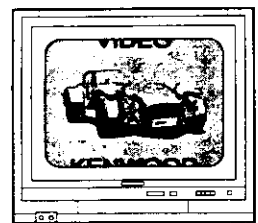

Maintenance

Cleaning

Unplug this appliance from the wall outlet before cleaning. Do not use volatile solvents such as alcohol, paint thinner, gasoline, or benzine, etc. to clean the cabinet. Use a clean dry cloth.

Caution against contact revitalizer

Do not use contact cleaners because it could cause a malfunction. Be specially careful against contact cleaners containing oil, for they may deform the plastic component.

Reference

Discs which can be played with this unit

DVD (12 cm, 8 cm), CD (12 cm, 8 cm), VCD, and the audio part of CDV, CD-G, CD-EG and CD-EXTRA.

- Use discs that comply with the IEC standard, for example a disc carrying the  marking on the label surface.

Never play a cracked or warped disc

During playback, the disc rotates at high speed in the player. Therefore, to avoid danger, never use a cracked or deformed disc or a disc repaired with tape or adhesive agent. Please do not use discs which are not round because they may cause a malfunction.

Disc accessories

The disc accessories (stabilizer, protection sheet, protection ring, etc.) which are marketed for improving the sound quality or protecting discs as well as the disc cleaner should not be used with this system because they may cause malfunction.

Disc handing precautions

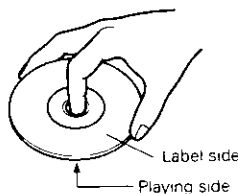

Handling

Hold the discs so that you do not touch the playing surface.

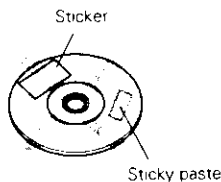

Do not attach paper or tape to either the playing side or the label side of the discs.

Cleaning

If fingerprints or foreign matter become attached to the disc, lightly wipe the disc with a soft cotton cloth (or similar) from the center of the disc outwards in a radial manner.

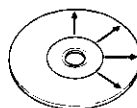

Storage

When a disc is not to be played for a long period of time, remove it from the player and store it in its case.

Note related to transportation and movement

Before transporting or moving this unit, carry out the following operations.

1. Set the POWER key to ON without loading a disc.
2. Wait a few seconds and verify that the display shown appears.
3. Set the POWER key to OFF.

NO DISC

Beware of condensation

When the difference between the internal temperature of the unit and external atmosphere is large, dew (mist) may be produced on the internal parts of the unit. In such a case, turn the unit ON and leave it for a few hours until the condensation has dried up.

Be especially careful in the following conditions:

When the unit is brought into a place where there is a large difference in temperature between the previous location, when the humidity of the listening room is high, etc.

System Connections

DV-203 (En/K)

Make connection as shown below. When connecting the related system components, refer also to the instruction manuals of the related components.

⚠ Caution: Do not plug in the power lead until all connections are completed.

Malfunction of microprocessor



If operation is not possible or erroneous display appears even though all connections have been made properly, reset the microprocessor referring to "In case of difficulty". → 56

15

Connection with TV with S-VIDEO jacks and general stereo system

Connection with VCR

The VIDEO OUTPUT jacks should be connected directly to the TV. Do not connect them to the TV via a VCR. Otherwise the played video may be disturbed due to the copy protection function.

Initial setup

Set initial setup [6. TV Aspect] according to the aspect ratio (4:3 or 16:9) of your TV. → 47

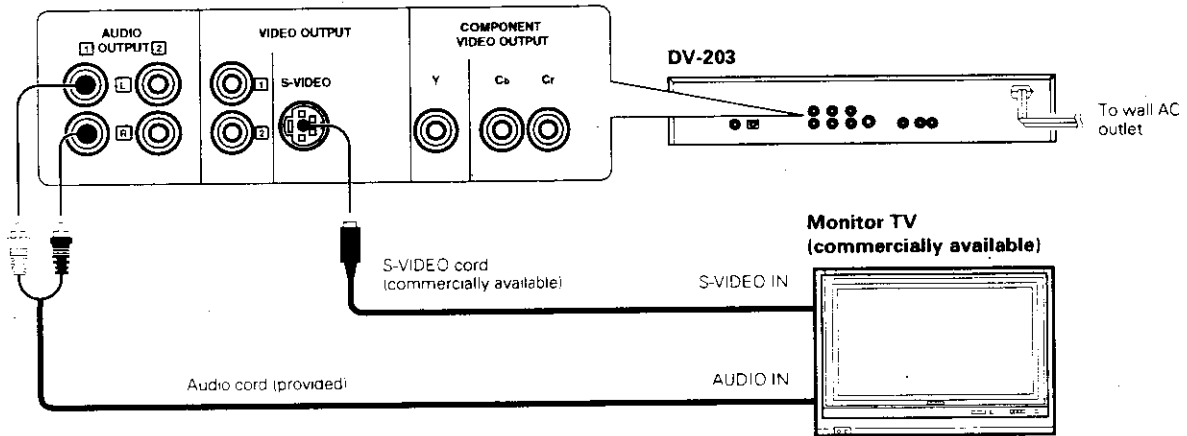

Connection with general stereo system

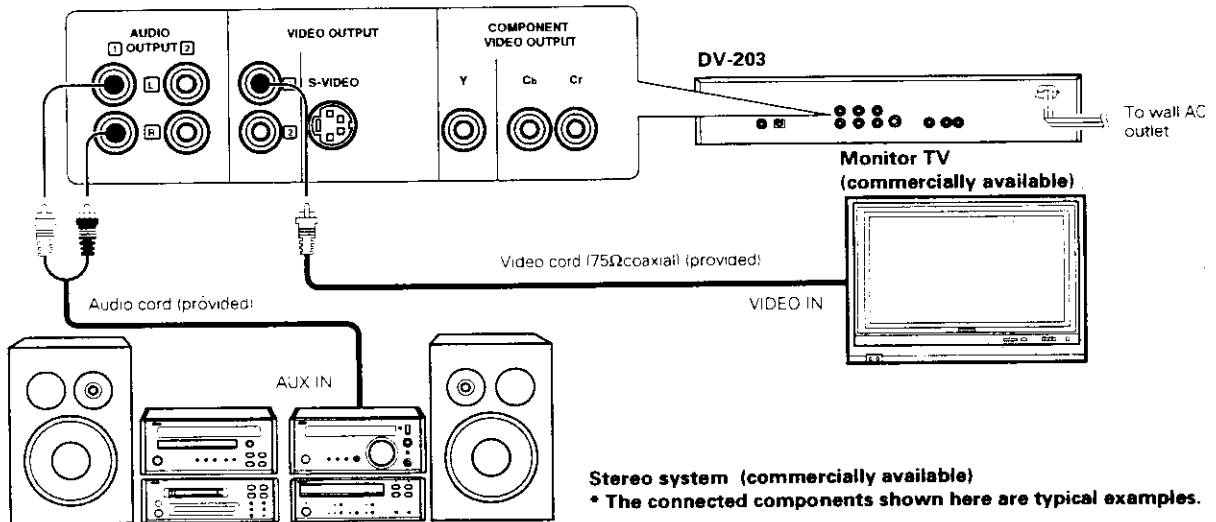

Stereo system (commercially available)
* The connected components shown here are typical examples.



1. Connect all cords firmly. If connections are loose, there could be loss of sound or noise produced.
2. When plugging and unplugging connection cords, be sure to first remove the power cord from the AC outlet. Plugging/unplugging connection cords without removal of the power cord can cause malfunctions or damage to the unit.

6 Connection with an AV receiver

This unit incorporates a Dolby Digital (AC-3) decoder. As a result, it can play DVD discs encoded with Dolby Digital (AC-3) without the need of purchasing a commercially available Dolby Digital (AC-3) decoder.
When playing DTS-encoded discs, connect Digital Output to AV receiver corresponds with DTS decoder to play DVD discs.

The output audio is variable depending on the played discs and setups. By referring to the following table, perform initial setup and other settings according to your system. ("Changing the initial setup" - 41)

Played Disc	Audio Recording System	Output Audio	
		Analog Output	Digital Output
DVD	Dolby Digital (AC-3)	6ch	•Bitstream •PCM (48kHz/16bit) 2ch
	Linear PCM	2ch	(*1) PCM (48kHz/16bit) 2ch
	DTS	Not output	(*2) Bitstream
	DTS of PCM area recording	(*3) May be interfered with noise.	PCM (DTS data)
VCD	MPEG 1	2ch	PCM (44.1kHz)
CD	Linear PCM	2ch	PCM (44.1kHz)
	DTS CD	(*3) May be interfered with noise.	PCM (DTS data)

(*1) When the [7 Digital Audio Output] of the initial setup is set to "1 Off", a DVD with a sampling frequency of 48 kHz (20 bit/24 bit) or 96 kHz cannot be played back. ("Changing initial setup [7 Digital Audio Output]" - 48)

(*2) The bitstream is not output if the DTS has been set to off in the initial setup.

(*3) When playing DTS-encoded (CDs, DVDs), excessive noise may be exhibited from the analog stereo outputs. To avoid possible damage to audio system, the consumer should take proper pre-cautions when the analog stereo outputs of the DVD player is connected to an amplification system. To enjoy DTS Digital Surround (tm) playback, an external 5.1 channel DTS Digital Surround (tm) decoder system must be connected to the digital output (S/PDIF, AES/EBU, or TosLink) of the DVD player.

About the linear PCM audio

This is the signal recording format used with music CD discs. While music CDs use 44.1 kHz/16-bit recording format, DVDs use from 48 kHz/16-bit to 96 kHz/24-bit formats so they can reproduce audio with a higher quality than music CDs.

Make connection as shown below. When connecting the related system components, refer also to the instruction manuals of the related components.

Caution: Do not plug in the power lead until all connections are completed.

The VIDEO OUTPUT jacks should be connected directly to the TV. Do not connect them to the TV via a VCR. Otherwise the played video may be disturbed due to the copy protection function.

Initial setup

Set initial setup [6. TV Aspect] according to the aspect ratio (4:3 or 16:9) of your TV.

DV-203

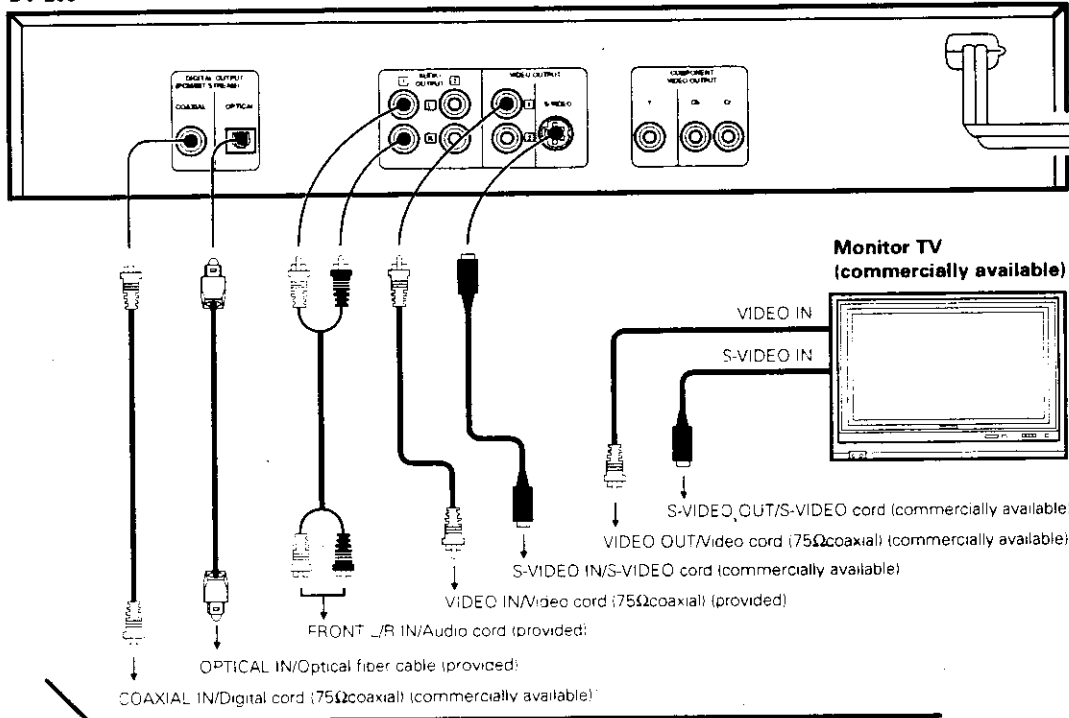

*If you want to use the macro function of a KENWOOD AUDIO VIDEO SURROUND RECEIVER (optional), connect this player to a wall AC outlet. Be sure to set the POWER switch on the front panel of this unit to OFF when you are going to leave the unit unattended for going out of the house, etc.

Connect the cords and cables according to the jacks available on the connected AV receiver.

AV receiver with 6-channel input (commercially available)

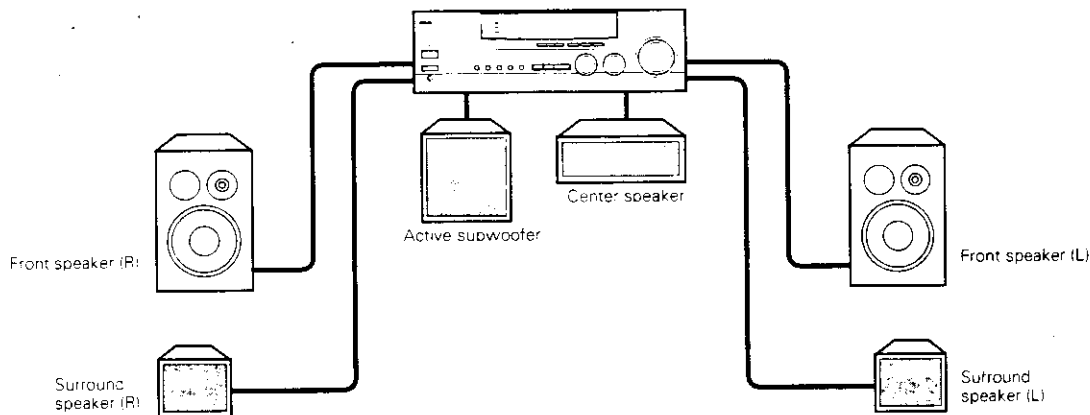

Stereo system (commercially available)

* The connected components shown here are typical examples.



1. Connect all cords firmly. If connections are loose, there could be loss of sound or noise produced.
2. When plugging and unplugging connection cords, be sure to first remove the power cord from the AC outlet. Plugging/unplugging connection cords without removal of the power cord can cause malfunctions or damage to the unit.

To connect with an AV receiver with built-in Dolby Digital (AC-3) decoder and digital input

Connect the DIGITAL OUTPUT jack of this unit with the DIGITAL INPUT jack of the AV receiver using an optical fiber cable or digital cord.

NOTE: Some DVD and CD discs contain DTS data in the PCM area. When such a disc is played, the AUDIO OUTPUT jack does not output correct audio.

Connection of S-VIDEO jacks

The S-VIDEO connection offers clear video because it transmits the video signal by separating it into the color (C) component and luminance (Y) component. It is recommended to use an S-VIDEO cord when the connected TV has an S-VIDEO input. For details, refer to the instruction manual of your TV.

Connection of color different output jacks

These jacks output the red (Cr), blue (Cb) and luminance (Y) signals independently to allow high fidelity in color reproduction. For details, please refer to the instruction manual of your TV.

- These outputs cannot be connected to the color-difference signal input jacks of the Hi-Vision HDTV system.

Digital output jacks (OPTICAL)

Remove the protective cap before using a digital output jack.



Remove cap.

Note on connection of optical-fiber cable

- Insert the optical-fiber cable straight into the connector until it clicks.
- Be sure to attach the protection cap when the connector is not used.
- Never bend or bundle the optical-fiber cable.
- All of the commercially-available optical fiber cables cannot be used with these units. If there is an optical fiber cable which cannot be connected to your component, please consult your dealer or nearest KENWOOD agent.

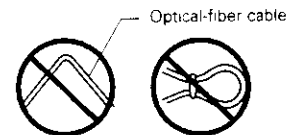

Copyright and copy protection notes

Manufactured under license from Dolby Laboratories. "Dolby" and the double-D symbol are trademarks of Dolby Laboratories. Confidential Unpublished Works. © 1992-1997 Dolby Laboratories. All rights reserved.

It is prohibited by laws to duplicate, broadcast, perform in public or rent a disc without the permission of the copyright owners.

"DTS" is a trademark of Digital Theater Systems, Inc.

This product incorporates copyright protection technology that is protected by method claims of certain U.S. patents and other intellectual property rights owned by Macrovision Corporation and other rights owners. Use of this copyright protection technology must be authorized by Macrovision Corporation, and is intended for home and other limited viewing uses only unless otherwise authorized by Macrovision Corporation. Reverse engineering or disassembly is prohibited.

This product is compatible with the MacroVision type copy protection. Some discs contain the recording of copy inhibit signals, and the video may be disturbed when the video of such discs is recorded onto a VCR and played back.

Display / Main unit

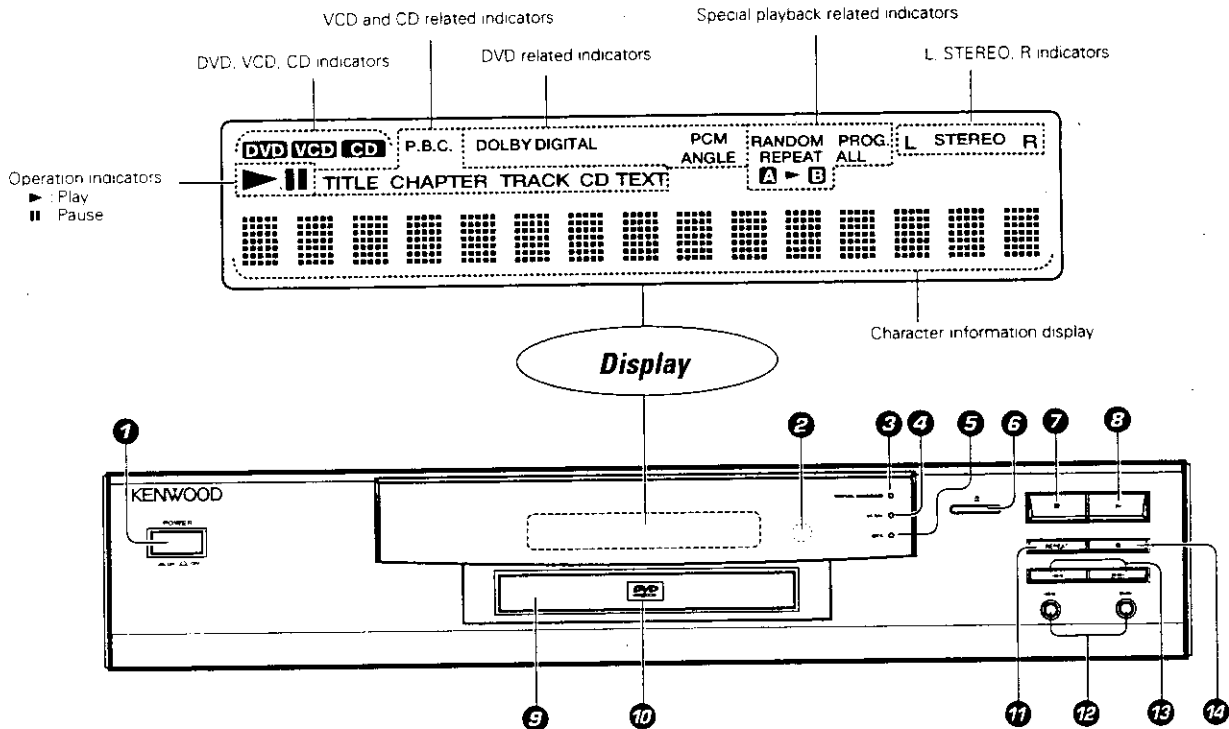

- ① POWER key - 22
- ② Remote control sensor - 21
- ③ VIRTUAL SURROUND indicator - 40
Lights during playback of an AC-3 5.1-channel disc by setting virtual surround.
- ④ 96 kfs indicator
Lights during playback of a DVD LPCM disc with 96 kfs sampling frequency
- ⑤ DTS indicator
Lights during playback of a DVD DTS disc.
- ⑥ Open/close (▲) key - 22

- ⑦ Stop (■) key - 25
- ⑧ Play (▶) key - 22
- ⑨ Tray panel
- ⑩ DVD badge
- ⑪ REPEAT key - 32
- ⑫ Manual search (◀▶) keys - 24
- ⑬ Skip down (◀) / up (▶) keys - 24
- ⑭ Pause (||) key - 24 - 25

Standby mode of the unit

While the POWER key is set to ON, this unit can be put to the standby mode using the graphical remote control unit provided with a KENWOOD AUDIO VIDEO SURROUND RECEIVER. When the STANDBY indicator of this unit is lit, a small amount of current flows in it to back up the internal memory. This status is referred to as the standby mode.

Remote control unit

The remote control unit incorporates the basic operation keys as well as a variety of applied operation keys so that it can be used in a wide range of purposes.

Use care to store the remote control unit in a safe place so as not to lose it.

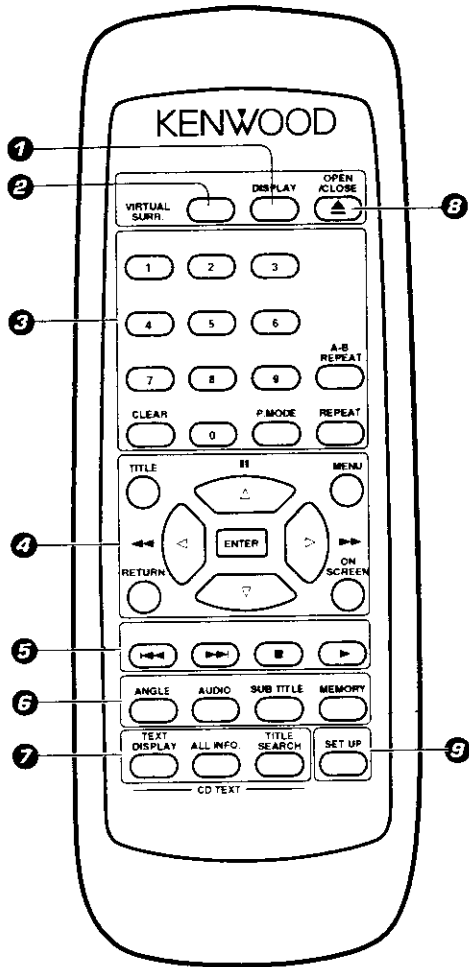

Model: RC-D0305
Infrared ray system

- ① DISPLAY key - 25
- ② VIRTUAL SURR. key - 40
- ③ CD, VCD and DVD related control keys
 - Numeric (0 to 9) keys - 23 - 43
 - CLEAR key - 29
 - P.MODE key - 25
 - A-B REPEAT key - 33
 - REPEAT key - 32
- ④ CD, VCD and DVD related control keys
 - Cursor (Δ, ∇, ◀, ▶) keys - 26
 - ENTER key - 23 - 26
 - Pause (||) key - 24 - 25
 - Forward and reverse search (◀◀, ▶▶) keys - 24
 - TITLE key - 39
 - MENU key - 38
 - RETURN key - 37 - 42
 - ON SCREEN key - 26
- ⑤ CD, VCD and DVD related control keys
 - Skip down (◀◀) and Skip up (▶▶) keys - 24
 - Stop (■) key - 25
 - Play (▶) key - 22
- ⑥ TV monitor related control keys
 - ANGLE key - 36
 - AUDIO key - 34
 - SUB TITLE key - 35
 - MEMORY key - 29
- ⑦ CD-TEXT related control keys
 - TEXT DISPLAY key - 53
 - ALL INFO. key - 53
 - TITLE SEARCH key - 52
- ⑧ OPEN/CLOSE (▲) key - 22
- ⑨ SET UP key - 41

Operation of remote control unit

DV-203 (En/K)

Loading batteries

21

① Remove the cover.

② Insert batteries.

③ Close the cover.

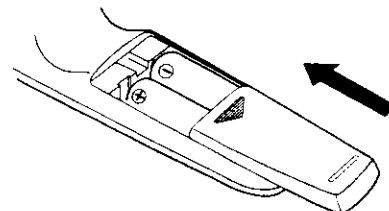
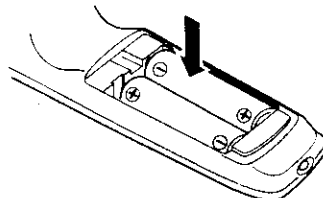
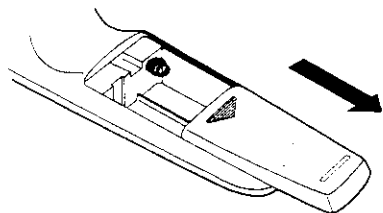

● Insert two R6 ("AA"-size) batteries following the polarity indications.

Operation

Insert the power plug into a power outlet, press the POWER key of the main unit to ON, then press the desired remote control key.

- When pressing more than one remote control keys successively, press the keys securely by leaving an interval of 1 second or more between pressing of keys.



1. The provided batteries are intended for use in operation checking, and their service life may be short.
2. When the remote controllable distance becomes short, replace both of the batteries with new ones.
3. If direct sunlight or the light of a high-frequency fluorescent lamp (inverter type, etc.) is incident to the remote sensor, malfunction may occur. In such a case, change the installation position to avoid malfunction.

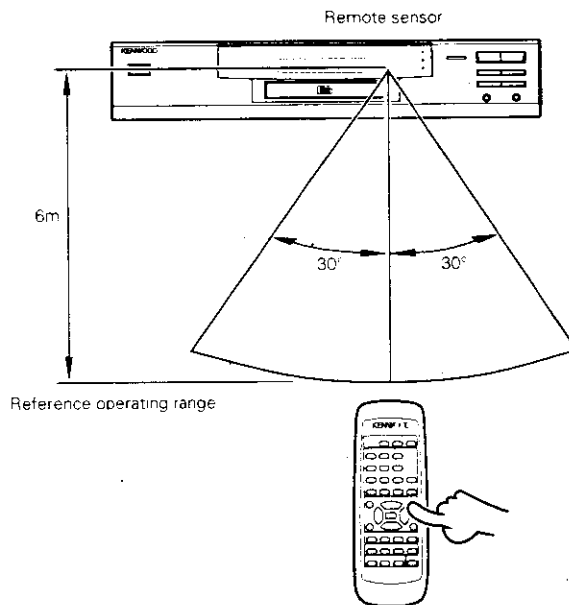

Basic operation of cursor keys

The cursor keys allows you to select or enter an icon or item displayed on the TV screen.

Basic operation

- ① Press one of the cursor (Δ , ∇ , \triangleleft , \triangleright) keys to select an icon displayed on the TV screen.
- ② Press the ENTER key to enter the selection.

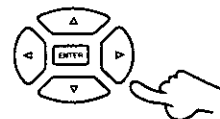

Preparations

Playback

The following procedure shows how to play a disc, such as a CD, VCD or DVD, from the beginning. When playing a VCD with P.B.C. (Play-Back Control) capability, please read "Menu playback".

22

Preparation

- 1 Turn on the TV and set the input source of the TV to "Video".
- 2 If the player is connected to a stereo system, etc., turn on the associated components and set its input source to "DVD".

Playing a disc from the beginning

1 Turn power ON.

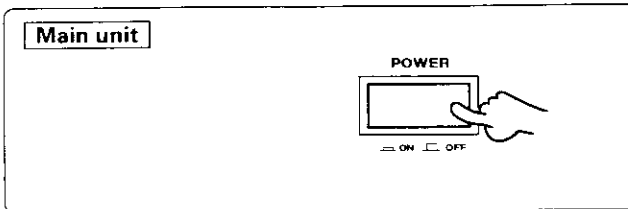

2 Insert (Remove) the disc.

Main unit

RC

- 1 Open the tray.
- 2 Insert (Remove) the disc.
- 3 Close the tray.

With certain discs, playback starts now.
If a menu screen appears on the TV screen, select the desired items as described in steps 4 and 5 before playing the disc.

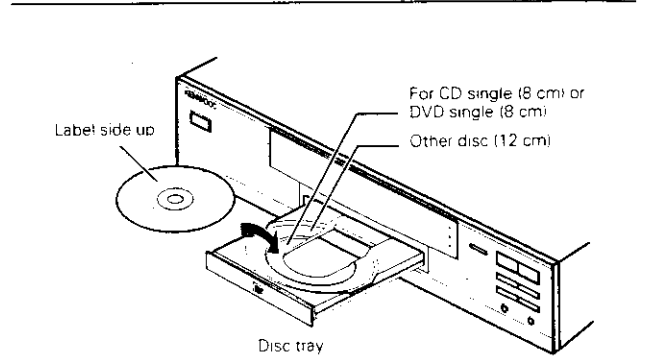

- Place the disc to be played properly by aligning it with the groove on the tray. (If the disc is not placed horizontally, malfunction will result.)
- Do not touch the played side.
- Load only one disc.
- This unit cannot use a commercially available CD single (8 cm) disc adapter.

3 Start playback.

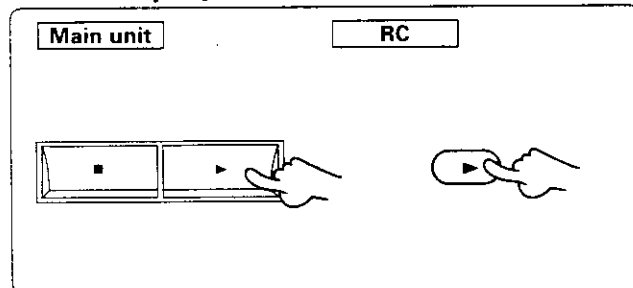

Display during disc play

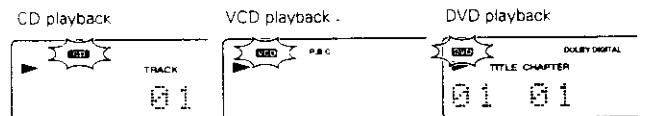

4 Select the desired items from the menu screen.

Menu screen: When an interactive DVD (DVD software containing multiple viewing angles or stories, for example) or a P.B.C.-compatible VIDEO CD is played, a menu screen is displayed in the beginning.

Example: Menu screen of a DVD with menu recording

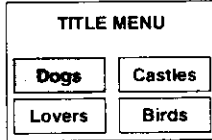

- The display, operation method and usable keys of the menu screen are variable depending on software. For details, read the instructions provided with the played software.

RC

Selection using cursor (Δ, ▽, ◀, ▶) keys (DVD only)

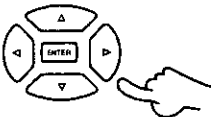

RC

① When a DVD is played, press the MENU key.



② Select an item with the numeric keys.

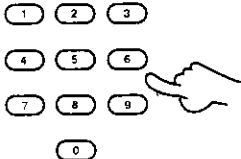

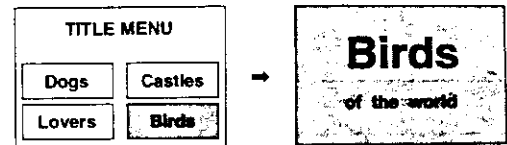

- When the menu has a hierarchical structure, the menu at the lower level appears.
- If there are more than one menu (scene) that can be selected, the menus (scenes) can be switched using the ►► (NEXT) and ◀◀ (PREV.) keys.

RC

Press numeric keys in the following order...

To select "5" : 5 ENTER

To select "17" : 1 7 ENTER

5 Press the ENTER key to start playback.

RC

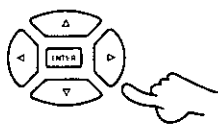

4 Forward search and reverse search (Manual search)

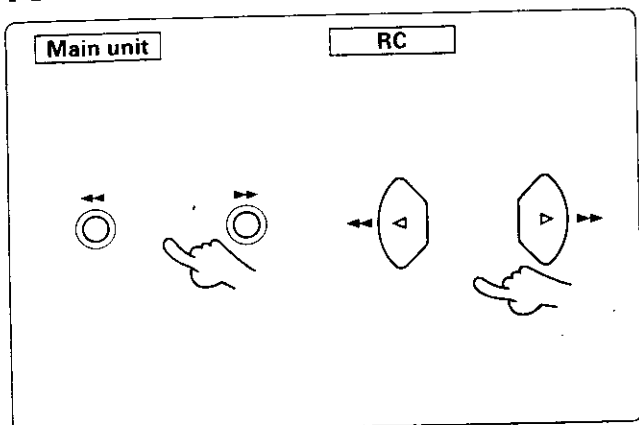

▶▶ : Forward search
 ◀◀ : Reverse search

- Press once to start and continue forward or reverse search at a low speed. The search speed can be adjusted in 5 steps
- Audio is not output during forward or reverse search. (DVD, VCD)
- The video may be disturbed during forward or reverse search.

When the ◀◀ or ▶▶ key is pressed during menu playback of a VCD, the screen may sometimes return to the menu screen.

Skipping tracks or chapters

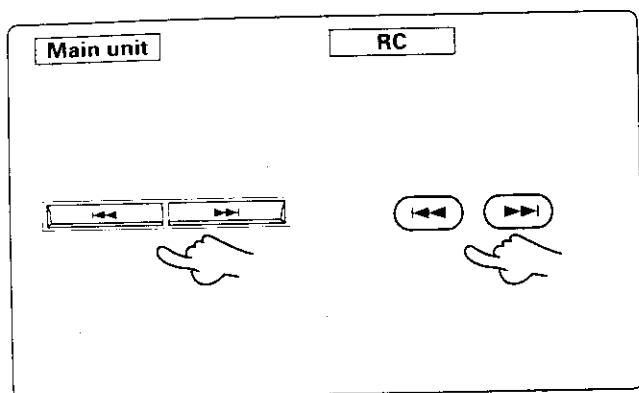

▶▶▶ : Skip up
 ◀◀◀ : Skip down

- Tracks are skipped in the direction corresponding to the pressed key, and playback resumes from the beginning of the track (chapter) reached after skipping.
- Pressing the ◀◀◀ key once during playback returns to the beginning of the current track (chapter).

When the ◀◀◀ or ▶▶▶ key is pressed during menu playback of a VCD, the screen may sometimes return to the menu screen.

Frame-by-frame playback

Software with which this function is available:



Press the II key during pause.

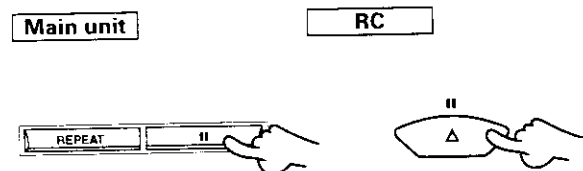

- Each press advances to the next frame.
- Press the ▶ key to resume normal playback.

Slow playback

Software with which this function is available:



Slow playback is possible in 5 speed steps.

Press the ▶▶ key or ◀◀ key during pause.

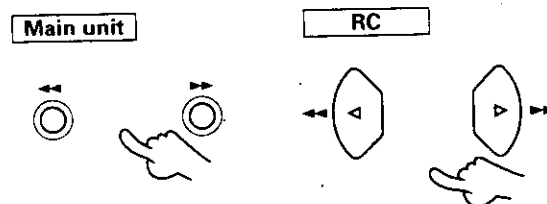

- Press the ▶ key to resume normal playback.

Reverse slow playback (◀◀◀) of a DVD consists of playing frame by frame backward and discontinuously. Reverse slow playback is not available with a VCD.

Playing tracks in a random order (Random playback)

Tracks in a CD or VCD can be played in a random order.

1 Enter stop mode.

- Before performing random playback of a P.B.C.-compatible VCD, cancel the P.B.C. function by pressing the ■ key.

2 Select the random play mode.

Each press switches the play mode as follows.

- 1 Track mode : PROG./RANDOM goes off
- 2 Program mode : PROG. lights up
- 3 Random play mode : RANDOM lights up

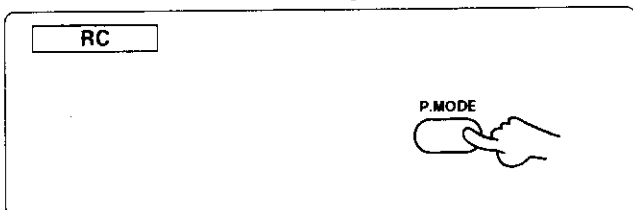

3 Start playback.

To return to normal playback

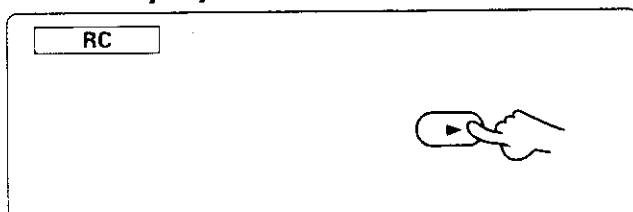

- 1 Press the ■ key.
- 2 Press the P.MODE key so that the RANDOM indicator goes out.

The following operation may not be available with certain DVD discs.

Letting playback pause

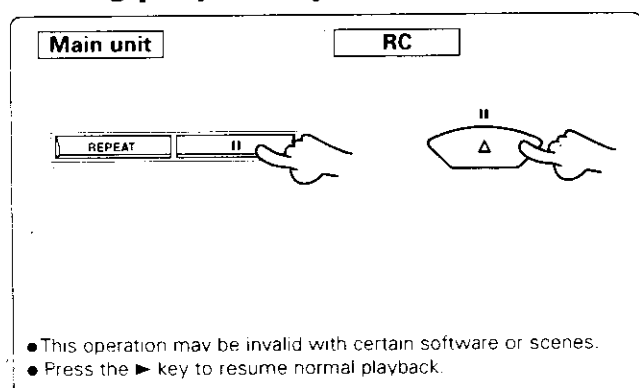

Stopping playback

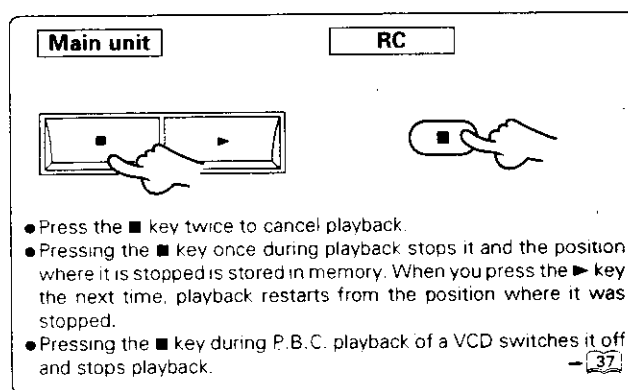

DISPLAY key

Each press of the DISPLAY key switches the main unit display on and off alternately. However, even when the display is off, the ► or || indicator lights up during playback or pause.

Each press switches the mode as follows.

- 1 Main unit display : lights up
- 2 Main unit display : goes off



26 Basic operations on the GUI screen

The icons displayed on the TV screen can be selected easily by using the ON SCREEN key and cursor (Δ , ∇ , \triangleleft , \triangleright) keys of the provided remote control unit.

1 Press the ON SCREEN key.

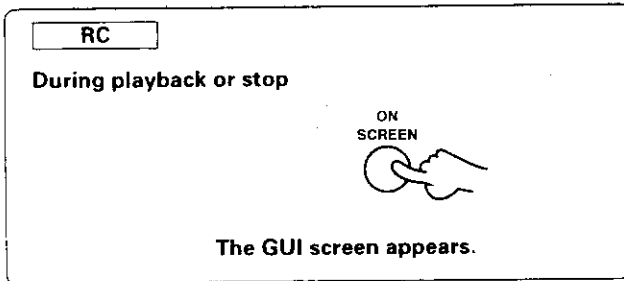

Each press switches the TV screen display as follows.

Example: With a DVD

1 Normal playback screen



3 Player information screen



4 Shuttle information screen



● The displayed items are variable depending on discs.

2 Select the item to be changed.

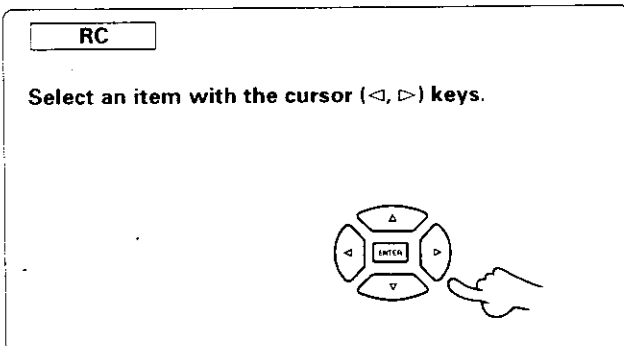

3 Change the content of the selected item.

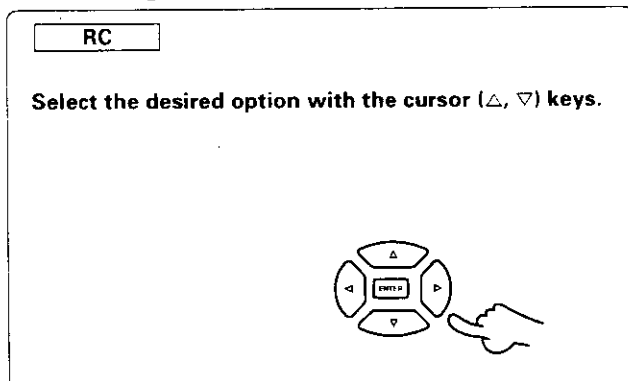

- Some of the changes are executed immediately while some are executed after the **ENTER** or **▶** key is pressed. Certain functions cannot be operated from the GUI screen displayed in stop mode.
- The item consisting of a number, such as a title, can be changed using numeric keys. When an item has been changed using numeric keys, press the **ENTER** key to execute the change.

Information related to the disc (title, chapter, time, voice language, subtitle language, angle, etc.) or the player (repeat mode, video quality, etc.) can be displayed and changed as required. The icons displayed on the TV screen are as shown below.

Software with which this function is available:



Icons on the TV screen

The Δ and ∇ markings in the icon frames indicate that the icon can be changed with the cursor keys on the main unit or remote control unit.

During DVD playback

Disc information screen

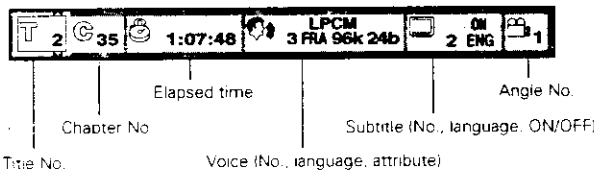

Player information screen

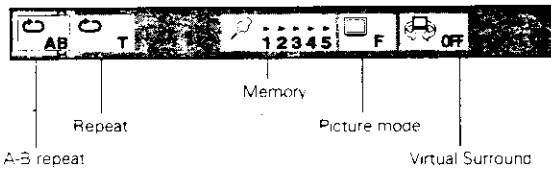

Shuttle information screen

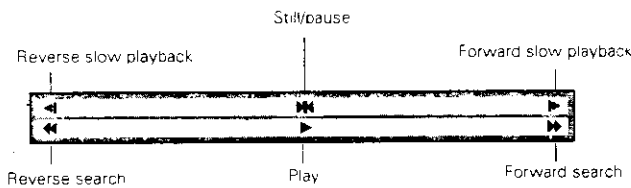

Voice language icons of DVD

Icon	Language	Icon	Language
ENG	English	POR	Portuguese
FRA	French	RUS	Russian
DEU	German	JPN	Japanese
ITA	Italian	CHI	Chinese
ESP	Spanish	KOR	Korean
NLD	Dutch	MAL	Malay
SVE	Swedish	VIE	Vietnamese
NOR	Norwegian	THA	Thai
DAN	Danish	•	Others

Picture mode (DVD and VCD only)

N	Normal quality
S	Soft quality
F	Fine quality

During VCD playback

Disc information screen

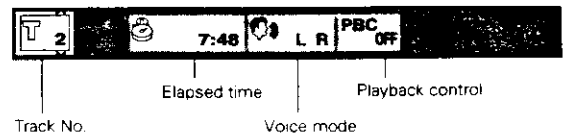

Player information screen

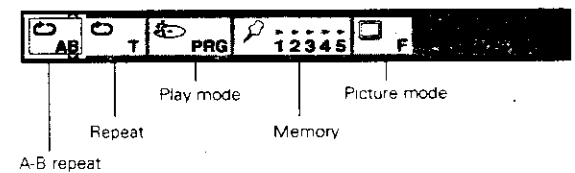

Shuttle information screen

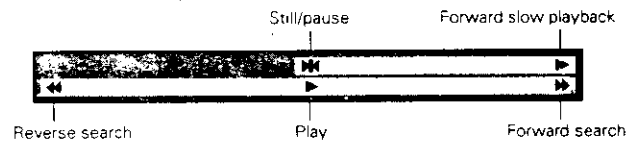

Audio mode (VCD only)

LR	Audio L + Audio R
L	Audio L
R	Audio R

During CD playback

Disc information screen

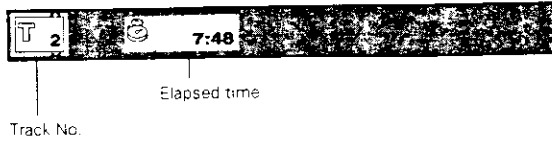

Player information screen

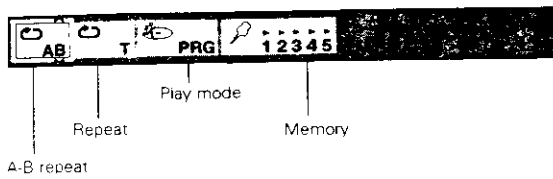

Shuttle information screen

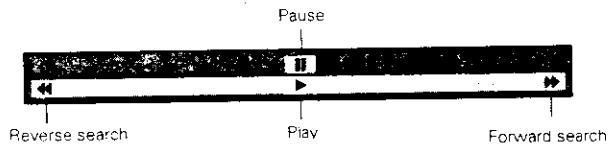

Storing scenes in memory (Memory function)

By storing scenes that you want to check later, subsequent playback can be started from any of the stored scenes any time. Up to 5 scenes can be stored (using the remote control unit only). This operation may not be available with certain DVD discs.

Software with which this function is available:



Storing a scene in memory

1 Press the **MEMORY** key during playback.

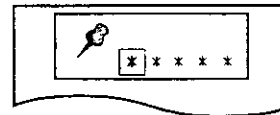
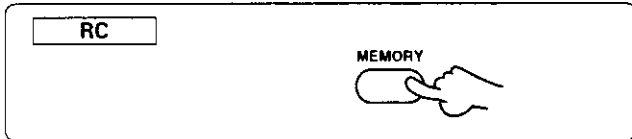

• “ * ” is displayed in positions where no scene is stored in memory.

2 Press the **ENTER** key at the scene you want to store in memory.

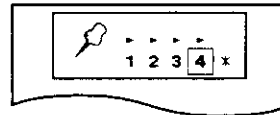
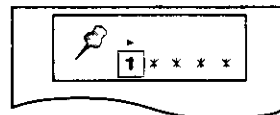
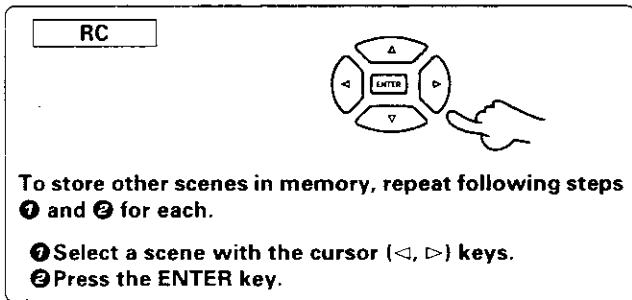

Recalling/clearing a scene in memory

1 Press the **MEMORY** key during playback.

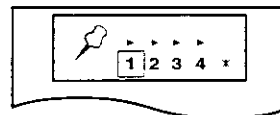
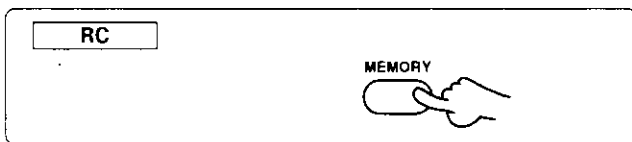

2 Select the memory number to be recalled or canceled.

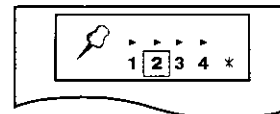
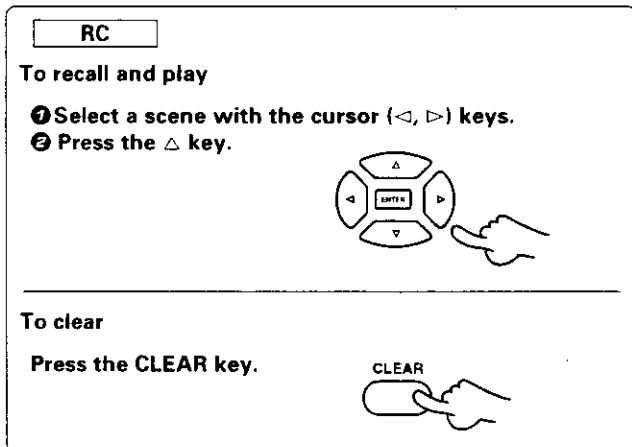

• The scene corresponding to the selected memory number is searched and playback starts from it.

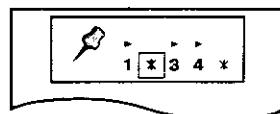

• The scene in the selected memory number is cleared.

Programming

DV-203 (En/K)

Desired tracks or chapters can be programmed and played back in a desired order. Up to 18 tracks (chapters) can be programmed but the attempt to program a 19th track (chapter) is rejected.

Software with which this function is available:



With a VCD, there is no relationship between the divisions in recording and the track numbers, except of certain software such as karaoke discs. As a result, the programming operation may not be usable depending on software.

Programming tracks in the desired order

1 Enter stop mode.

2 Select the program mode.

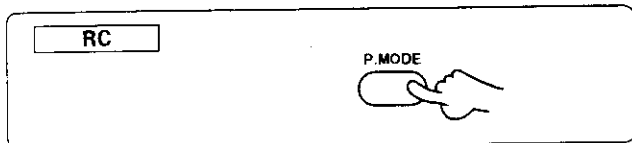

• To perform program playback of a P.B.C.-compatible VCD, first press the ► key then the ■ key to cancel the P.B.C. function.

Each press of the P.MODE key switches the play mode as follows.

- 1 Track mode : PROG./RANDOM goes off
- 2 Program mode : PROG. lights up
- 3 Random play mode : RANDOM lights up

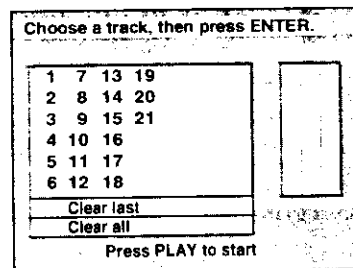

3 Select the desired tracks (chapters) in the order you want to play them later.

RC

- 1 Select a track (chapter) number with the cursor (▲, ▼, ◀, ▶) keys.
- 2 Press the ENTER key.

- 3 Program other tracks (chapters) by repeating steps 1 and 2 for each of them.

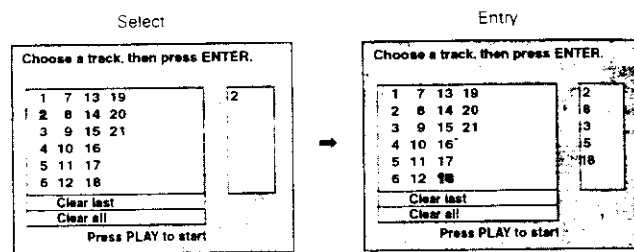

Tracks (chapters) can also be selected with numeric keys.

- To select track (chapter) No. 8 : **8** ENTER
- To select track (chapter) No. 18 : **1** **8** ENTER

- Select "Clear last" with the cursor keys and press the **ENTER** key to clear the currently last track (chapter) in the program one by one.
- The entire program can also be cleared by selecting "Clear all" with the cursor keys then pressing the **ENTER** key.
- If you made a mistake, press the **CLEAR** key and select the correct track (chapter).

4 Play the program.

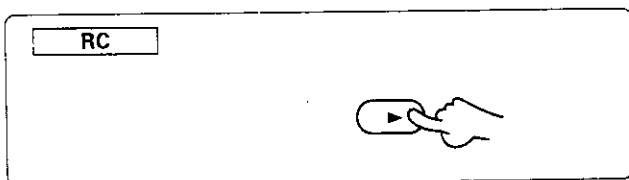

- Tracks (chapters) will be played in the order you programmed them (i.e. in order of program numbers).
- Pressing the ◀◀ or ▶▶ key during program playback skips to the previous or next track (chapter) in the program.

Adding tracks (chapters) in the program

RC

① Select a track (chapter) number with the cursor (Δ, ∇, ◀, ▶) keys.

② Press the ENTER key.

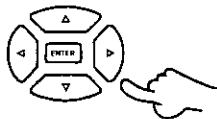

③ If you want to add more tracks (chapters), repeat steps ① and ② for each of them.

Select

Choose a track, then press ENTER.

1	7	13	19	2
2	8	14	20	18
3	9	15	21	3
4	10	16		5
5	11	17		18
6	12			7

Clear last
Clear all

Press PLAY to start

Entry

Choose a track, then press ENTER.

1	7	13	19	2	10
2	8	14	20	18	
3	9	15	21	3	
4	10	16		5	
5	11	17		18	
6	12	18		7	

Clear last
Clear all

Press PLAY to start

Tracks (chapters) can also be selected with numeric keys.

To select track (chapter) No. 7 : **7** ENTER

To select track (chapter) No. 10 : **1** **0** ENTER

• The track is added to the last of the program.

Clearing tracks (chapters) from the program

RC

To clear the last track in the program



- Each press of the **CLEAR** key clears the last track (chapter) in the current program.
- The entire program can also be cleared by selecting "Clear all" with the cursor keys then pressing the **ENTER** key.

Returning to normal playback

RC

Press in stop mode.

Press so that the PROG./RANDOM indicator turns off.

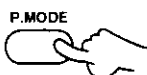

Repeating tracks, chapters or titles (Repeat playback, A-B repeat)

DV-203 (En/K)

Desired scenes or audio can be played repeatedly.

Software with which this function is available:



With a VCD, there is no relationship between the divisions in recording and the track numbers, except of certain software such as karaoke discs. As a result, the programming operation may not be usable depending on software.
The programming operation may also be unavailable with certain DVD discs.

Repeating a single track (chapter or title) (Repeat playback)

Before performing repeat playback of a P.B.C.-compatible VCD, cancel the P.B.C. function by pressing the **■** key.

RC

① Select the track mode.

P.MODE 

② Start playback.



③ Press the REPEAT key to select CHAPTER REPEAT, TITLE REPEAT or TRACK REPEAT.

REPEAT 

Each press of the P.MODE key switches the play mode as follows.

- 1 Track mode : PROG./RANDOM goes off
- 2 Program mode : PROG. lights up
- 3 Random play mode : RANDOM lights up

Each press of the REPEAT key switches the play mode as follows.

With a DVD:

- 1 CHAPTER REPEAT : Repeats a chapter.
- 2 TITLE REPEAT : Repeats a title.
- 3 NORMAL PLAY : Repeat off.

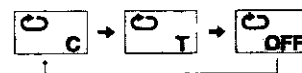

With a CD or VCD:

- 1 TRACK REPEAT : Repeats a track.
- 2 ALL REPEAT : Repeat the entire disc.
- 3 NORMAL PLAY : Repeat off.



To stop repeat playback

Press the REPEAT key repeatedly until "OFF" is displayed.

Repeating entire disc (Repeat playback)

Before performing repeat playback of a P.B.C.-compatible VCD, cancel the P.B.C. function by pressing the **■** key.

RC

① Select the track mode.

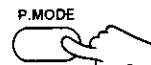
P.MODE 

② Start playback.

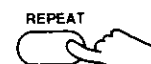

③ Press the REPEAT key to select ALL REPEAT.

REPEAT 

Each press of the P.MODE key switches the play mode as follows.

- 1 Track mode : PROG./RANDOM goes off
- 2 Program mode : PROG. lights up
- 3 Random play mode : RANDOM lights up

Each press of the REPEAT key switches the play mode as follows.

With a DVD:

- 1 CHAPTER REPEAT : Repeats a chapter.
- 2 TITLE REPEAT : Repeats a title.
- 3 NORMAL PLAY : Repeat off.

With a CD or VCD:

- 1 TRACK REPEAT : Repeats a track.
- 2 ALL REPEAT : Repeat the entire disc.
- 3 NORMAL PLAY : Repeat off.

To stop repeat playback

Press the REPEAT key repeatedly until "OFF" is displayed.

Repeating a desired section (A-B repeat)

A section specified during playback can be played repeatedly.

RC

1 Select the track mode.

P.MODE



2 Start playback.



3 Press the key at the point you want to start repeating.

Point A

A-B REPEAT



4 Press the key again at the point you want to end repeating.

Point B

A-B REPEAT



Each press of the P.MODE key switches the play mode as follows.

- | | |
|--------------------|-------------------------|
| 1 Track mode | : PROG./RANDOM goes off |
| 2 Program mode | : PROG. lights up |
| 3 Random play mode | : RANDOM lights up |

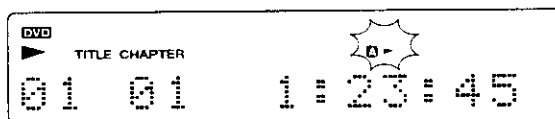
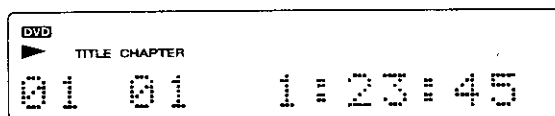

- Start point A is specified.

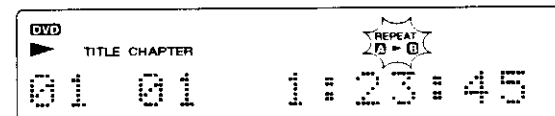

- End point B is specified and repeated playback of the section between A and B starts.

To stop repeat playback

Press the A-B REPEAT key again.

Repeating program playback (Program repeat) (CD, VCD only)

Programmed tracks can be played repeatedly by pressing the REPEAT key during program playback.

- 1** Perform steps **1** to **4** of the procedure in "Programming tracks in the desired order".

- 2** Select the all-program repeat mode.

RC

REPEAT



Each press switches the repeat mode as follows.

- Normal play screen
- Track repeat screen
- All-program repeat screen
- Repeat off screen



- The display contents are variable depending on discs.

Versatile DVD play features

DV-203 (En/Ki)

The following operations may not be available with certain DVD discs.

Software with which this function is available:



Remote control unit only

Switching the voice language (Multi-audio function)

When a DVD disc contains recording of voices in multiple languages, the languages can be switched during playback.

1 Press the AUDIO key during playback.

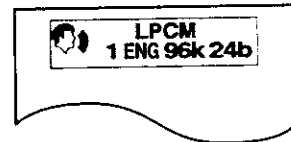
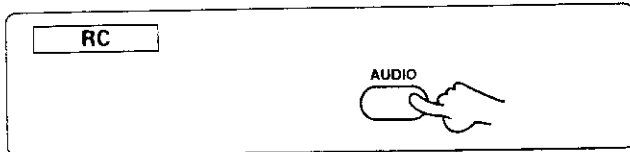

The language selected in the initial setup is used immediately after turning power on or replacing disc. If the initially set language does not exist in the disc, the priority language defined for each disc is used.

• The voice language display becomes " * " when no voice is recorded in the disc.

2 Select the voice language with the cursor (Δ , ∇) keys.

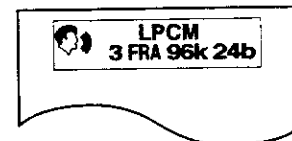
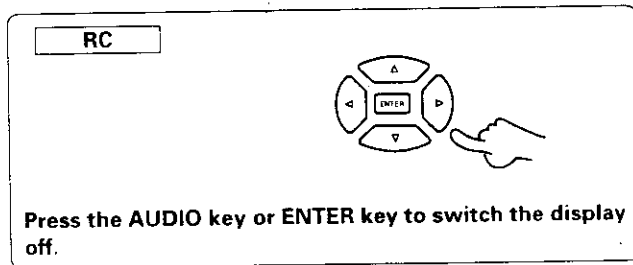

• If the desired language cannot be displayed by pressing a cursor key repeatedly, the desired language may not be recorded in the current disc.

Switching the vocal of karaoke software on and off

1 Press the AUDIO key during playback.

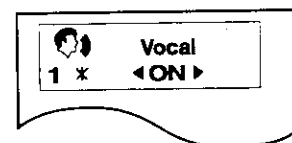
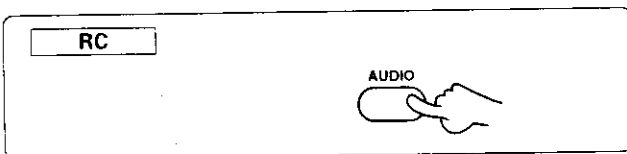

2 Select the voice language with the cursor (Δ , ∇) keys.

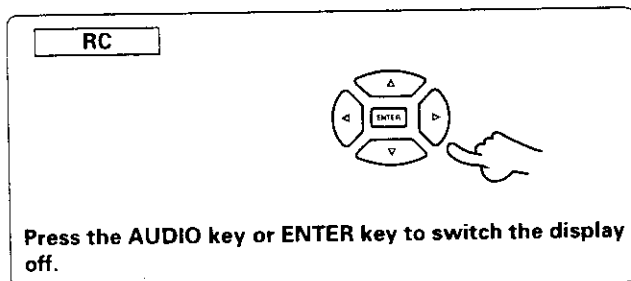

DVD karaoke (1-vocal disc)
ON ---- (OFF)

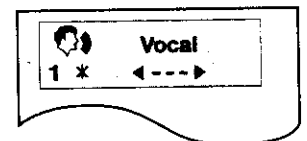

DVD karaoke (2-vocal disc)
1+2 → V1 → V2 → ---- (OFF)

• Select an option with the cursor keys (\leftarrow , \rightarrow).

VCD karaoke (2-vocal disc)
L R → L → R



• Select an option with the cursor keys (Δ , ∇).

The following operation may not be available with certain DVD discs.

Software with which this function is available:





Remote control unit only

Displaying/switching the subtitle language (Multi-subtitle function)

When a DVD disc contains recording of subtitles in multiple languages, the languages can be switched during playback.

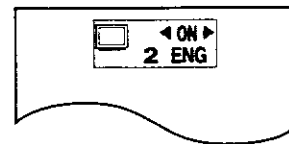
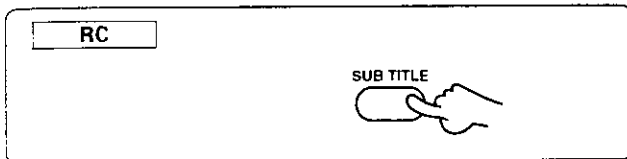
1 Press the SUB TITLE key during playback.



 The language selected in the initial setup is used immediately after turning power on or replacing disc. If the initially set language does not exist in the disc, the priority language defined for each disc is used.

2 Select the subtitle language with the cursor (Δ , ∇) keys.

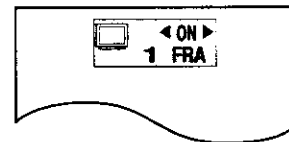
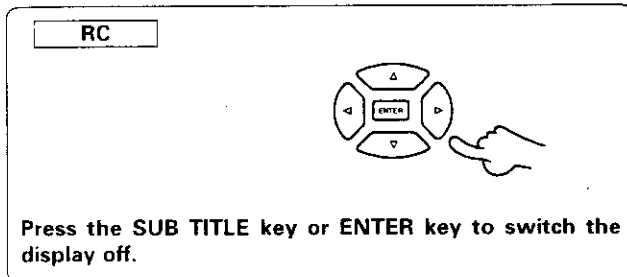

• If the desired language cannot be displayed by pressing a cursor keys repeatedly, the desired language may not be recorded in the current disc.

Switching the subtitle on and off

The subtitle display can be switched on and off with the cursor (\triangleleft , \triangleright) keys.

The following operation may not be available with certain DVD discs.

6 **Software with which this function is available:**



Remote control unit only

To switch the viewing angle (Angle function)

When the DVD disc being played contains the scenes recorded from multiple viewing angles, the angle can be switched while the ANGLE indicator is lit.

1 Press the ANGLE key while the ANGLE indicator is lit during playback.

RC

ANGLE



Press ANGLE key while this is lit.

DVD DOLBY DIGITAL ANGLE

TITLE CHAPTER

01 01 1:23:45

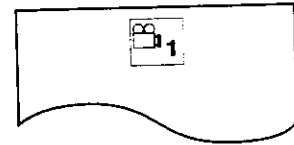

Operations

2 Select the viewing angle with the cursor (Δ , ∇) keys.

RC

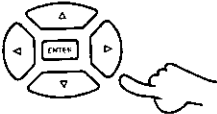

Press the ANGLE key or ENTER key to switch the display off.

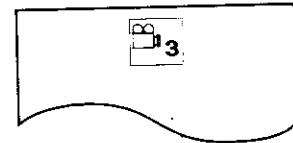

Menu playback

DV-203 (En/K)

Software with which this function is available:



Hierarchical structure of VCD menus

When an item is selected on the menu screen during playback of a P.B.C.-compatible VCD, another menu with more details items may be displayed. When a number of menus are connected in multiple layers in this way, it is said that the menus have a hierarchical structure. In this structure, the desired scene can be reached by repeating item selections on the menu screens.

Example for a hierarchical structure

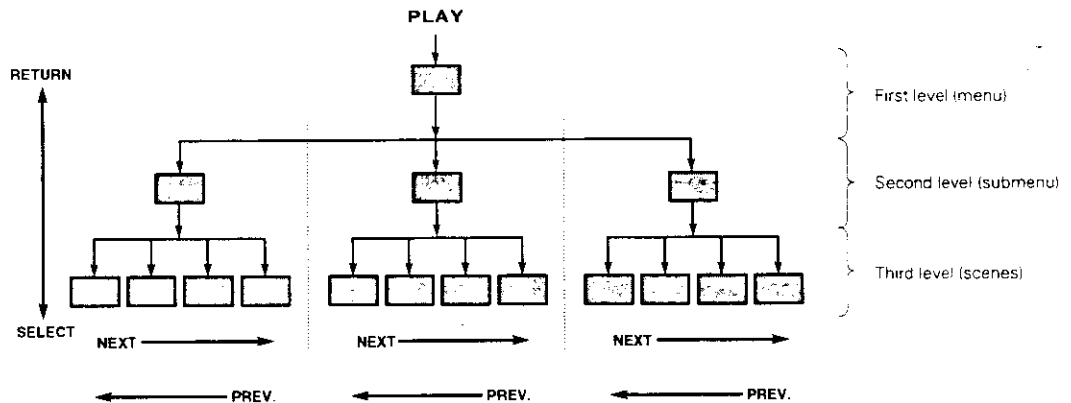

Advancing

When an item is selected on the menu screen with the ► key or the numeric keys, advance is made to the next lower menu level. When the advance destination is the "scene" to be played, the contents will be played.

- When several menus (scenes) can be selected in each level, screen switching is possible with the keys ►► (NEXT) and ◀◀ (PREV.).

Returning

Each time the RETURN key is pressed, return is made to the next higher menu.

Examples of operation keys and indications used during VCD playback

Soft jacket indication	▶	⏪	⏩	⏮	⏭
KENWOOD operation key	Play	RETURN	SKIP DOWN	SKIP UP	

- Depending on the software, the jacket indication may differ from the above.

Playback without using the menu playback function (In case of a P.B.C.-compatible VCD)

RC

- 1 Press the ■ key while a menu is displayed.
- 2 Enter the desired track number using the numeric keys or the ◀◀ and ►► keys.
- 3 Press the ▶ key to start playback.

- For the track numbers, refer to the disc jacket or other material.
- Press numeric key "1" if you want to play the disc from the beginning.

To return to menu playback

Press the ■ key twice then the ▶ key.

When a DVD disc containing the menu recording is played, the menu screen is displayed. You can select the playback contents in an interactive manner.

Software with which this function is available:



Menu playback (DVD)

Remote control unit only

1 Press the MENU key.

RC

MENU

The DVD menu appears.

DVD MENU	
1.	SUB TITLE
2.	AUDIO
3.	ANGLE

- Pressing the **MENU** key again returns to the screen from which you recalled the DVD menu and starts playback from there.

2 Select the desired item from the menu screen.

RC

- Select an item with the cursor (Δ , ∇ , \triangleleft , \triangleright) keys.
- Press the ENTER key to start playback.

To display other menus, perform steps 1 and 2 above.

DVD MENU	
1.	SUB TITLE
2.	AUDIO
3.	ANGLE

Menu items can also be selected with numeric keys.

To select "2" : **2** ENTER

- When the menu has a hierarchical structure, the menu at the lower level appears.



The display, operation method and usable keys of the menu screen are variable depending on software. For details, read the instructions provided with the played software.

Software with which this function is available:



Remote control unit only

Title selection using the title menu (Title function)

When a disc contains multiple titles, the desired title can be selected and played from the title menu.

1 Press the TITLE key during playback.

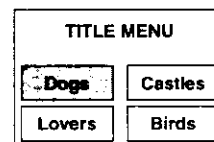
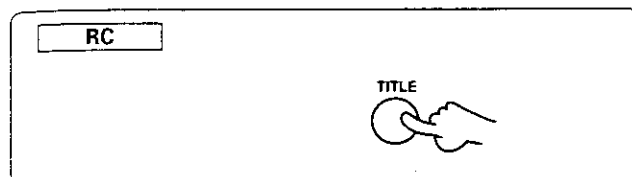

2 Select the desired title.

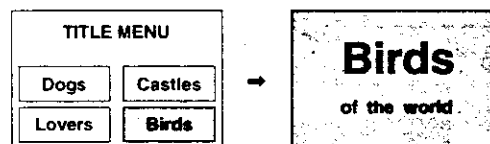
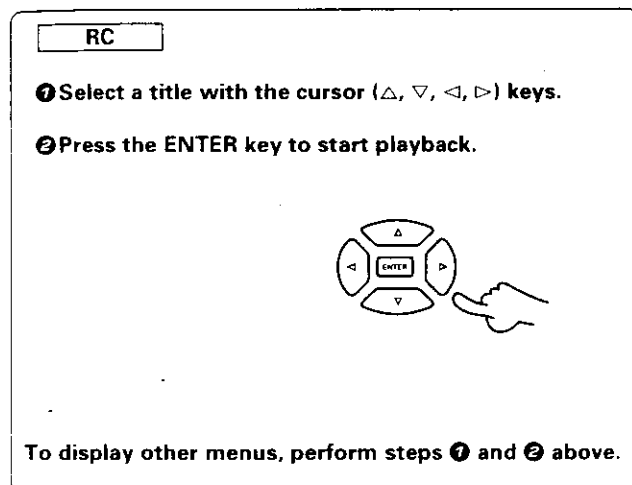

Menu items can also be selected with numeric keys.

To select "4" : 4 ENTER

To return to the menu screen

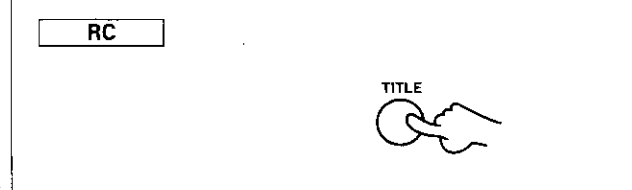

To stop playback

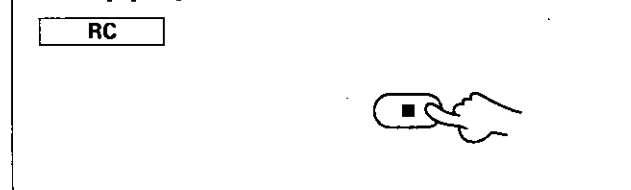

Even when your system uses only two speakers, a DVD recorded with Dolby Digital 5.1-channel surround audio can be played as if there were rear speakers on your sides, by simply switching the Virtual Surround function on.

Software with which this function is available:



Enjoying Virtual Surround sound (VIRTUAL SURR.)

1 Start playback.

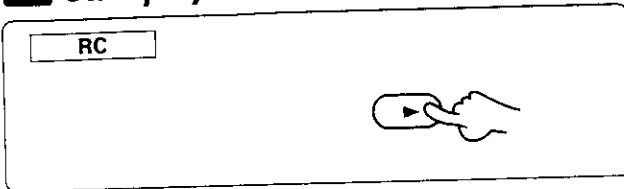

2 Press the VIRTUAL SURR. key.

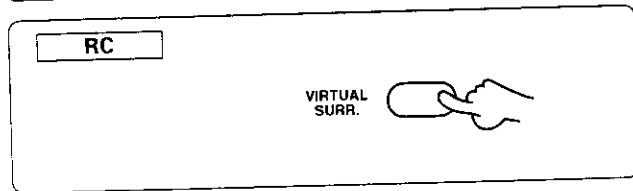

Main unit display

Lights only when a DVD AC-3 5.1-channel disc is played

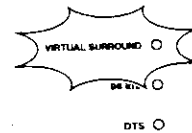

Each press switches the Virtual Surround as follows.

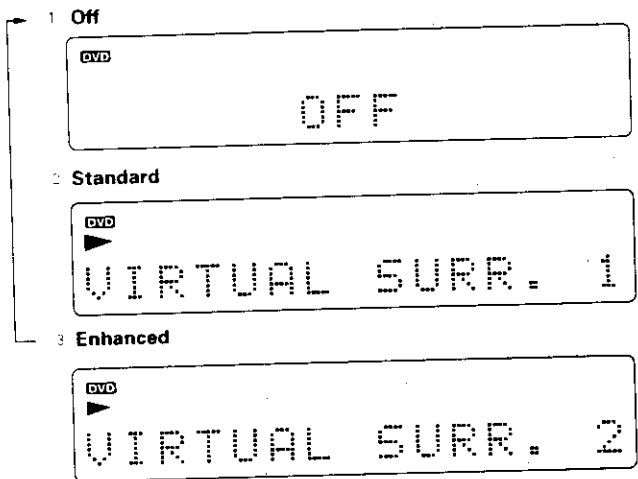

- This function is available only with DVD software encoded with Dolby Digital 5.1-channel surround audio.
- Switch this function off when the played disc uses other surround function.

Changing the initial setup

The initial setup of the player, which has been made at the factory, can be changed to the desired setup.

[1 Disc Languages]

This sets the language to be used when playing a disc. (If a disc does not contain the recording the selected language, it is played in the priority language set for each disc.)

[2 Ratings]

This can restrict playback of adult-oriented DVD discs that you do not want to be seen by children. However, even when a DVD disc is marked "Adult-oriented" or so on the label, its viewing cannot be restricted unless the restriction level is recorded in the disc itself.

[3 Menu Language]

This sets the initial setup of language as well as the language used in on-screen messages such as "PLAY".

[4 On-Screen Messages]

This sets whether the on-screen messages such as "PLAY" are to be displayed on the TV screen or not.

[5 FL Display]

This sets the brightness of the main unit display.

[6 TV Aspect]

This sets the screen size (4:3 or 16:9 aspect ratio) according to the connected TV.

[7 Digital Audio Output]

This sets the type of audio output from the digital audio output jack.

[9 Other Settings]

This sets special settings such as the audio dynamic range compression.

[0 Exit]

This exits the initial setup screen.

These operations may not be available depending on DVD discs.

Basic operation for changing the initial setup

1 Press the SET UP key in stop mode.

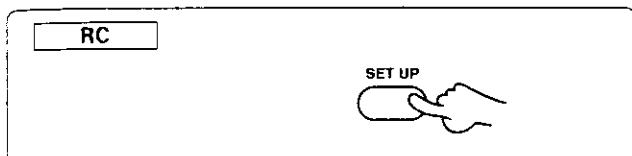

2 Select the item to be set.

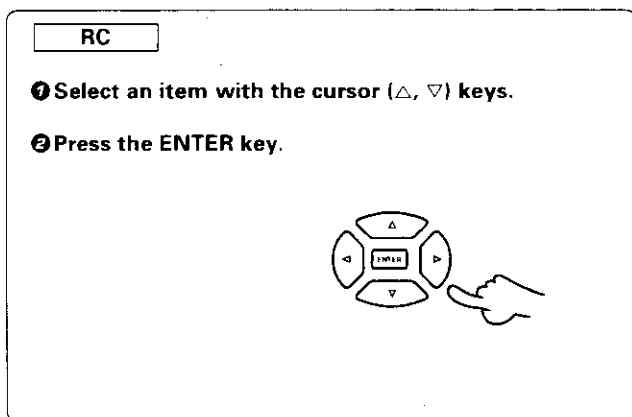

Initial setup screen

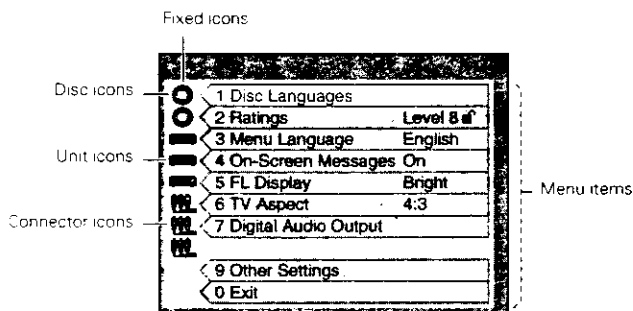

Each press of the cursor (Δ, ▽) key switches the item as follows.

- | | | | |
|---|------------------------|---------------------------|----|
| 1 | 1 Disc Languages | : To change setup, see | 42 |
| 2 | 2 Ratings | : To change setup, see | 43 |
| 3 | 3 Menu Language | : To change setup, see | 45 |
| 4 | 4 On-Screen Messages | : To change setup, see | 45 |
| 5 | 5 FL Display | : To change setup, see | 46 |
| 6 | 6 TV Aspect | : To change setup, see | 47 |
| 7 | 7 Digital Audio Output | : To change setup, see | 48 |
| 9 | 9 Other Settings | : To change setup, see | 50 |
| 0 | 0 Exit | : Exits the setup screen. | |

See subsequent pages for the actual setup change procedures.

Changing initial setup [1 Disc Languages]

1 Perform steps **1** and **2** of the procedure in "Basic operation for changing the initial setup".

2 Select the item to be set.

RC

1 Select an item with the cursor (Δ, ▽) keys.

2 Press the ENTER key.

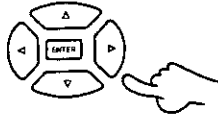

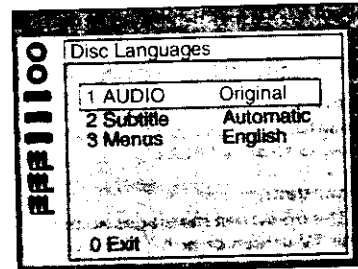

Each press of the cursor (Δ, ▽) key switches the items as follows.

- 1 1 AUDIO : Sets the voice language output from the speakers.
- 2 2 Subtitle : Sets the subtitle language displayed on the TV screen.
- 3 3 Menus : Sets the language used in on-screen messages including title menus (menus recorded in each disc).
- 4 0 Exit : Exits the current screen.

3 Select the desired option.

RC

1 Select an item with the cursor (Δ, ▽) keys.

2 Press the ENTER key.

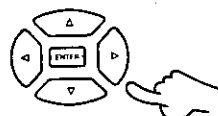

The setup completes and the initial setup screen appears again.

Setting options

When [1 AUDIO] is selected

- 1-3 English/French/Spanish : Select the desired voice language.
- 4 Original (Factory setup) : Select this option when you want to play discs in their priority languages.
- 5 Other * * * * : Select this option when you want other language than the above.
 - Enter the 4-digit language code with numeric keys. See "DVD menu language code list".

When [2 Subtitle] is selected

- 1 Automatic (Factory setup) : The subtitle language is set automatically according to the voice language.
 - No subtitle is displayed if the voice is played in the language set with "1 AUDIO".
 - If the voice is not played in the language set with "1 AUDIO", the subtitle is displayed in that language.
- 2-4 English/French/Spanish : Select the desired subtitle language.
- 5 Other * * * * : Select this option when you want other language than the above.
 - Enter the 4-digit language code with numeric keys. See "DVD menu language code list".

When [3 Menus] is selected

- 1-3 English/French/Spanish : Select the desired menu language.
- 4 Other * * * * : Select this option when you want other language than the above.
 - Enter the 4-digit language code with numeric keys. See "DVD menu language code list".

If you commit a mistake in the language number input

Each press of the CLEAR key clears the currently last digit. Be sure to input the correct digit(s) after clearing.

To return to the previous menu screen

Press the RETURN key.

To exit initial setup

Select "0 Exit" in the initial setup screen.

Changing initial setup [2 Ratings]

When the restriction level of the disc is [Level 8], i.e. without any restriction

1 Perform steps **1** and **2** of the procedure in "Basic operation for changing the initial setup".



2 Select the item to be set.

RC

① Select an item with the cursor (Δ, ▽) keys.

② Press the ENTER key.

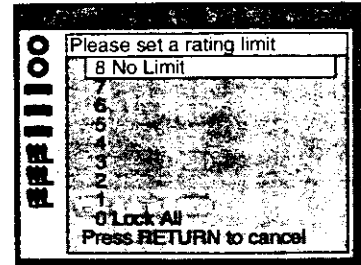

Each press of the cursor (Δ, ▽) key switches the items as follows.

- 1 8 No Limit (Factory setup)
 - : Plays any software (including adult-, general- and children-oriented).
- 2 Levels 7 to 2
 - : Plays general- and children-oriented DVD software.
 - Restricts playback of adult-oriented DVD software.
- 3 Level 1
 - : Plays children-oriented software.
 - Restricts playback of adult and general-oriented DVD software.
- 4 0 Lock All
 - : Inhibits playback of any DVD software. Select this item when you want to restrict playback of adult-oriented DVD software without viewing restriction level recording.

3 Enter the password.

The password should be set if you selected level 7 or less.

RC

① Input the 4-digit password with numeric keys.

② Press the ENTER key.

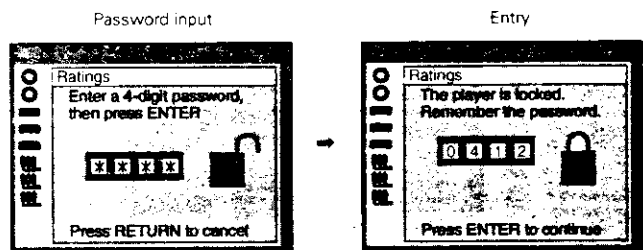

- Write down the 4-digit password and retain the memo carefully.
- If you locked the setup, it can no longer be changed except by inputting the correct password.

When the restriction level of the disc is [Level 0 to 7], i.e. with certain restriction

1 Perform steps **1** and **2** of the procedure in "Basic operation for changing the initial setup"...

2 Input the correct password.

RC

① Input the 4-digit password with numeric keys.

② Press the ENTER key.

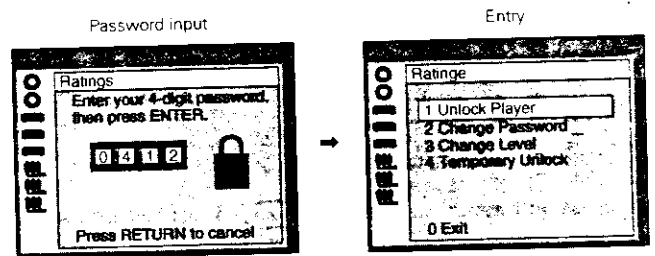

Setting details

To release viewing restriction

Press numeric key "1" then the ENTER key.

To change the password

- ① Press numeric key "2".
- ② Input a password with numeric keys and press the ENTER key.
- ③ Press the ENTER key.

To change the viewing restriction level

- ① Press numeric key "3".
- ② Select a level with the cursor {Δ, ▽} keys and press the ENTER key.

To release the viewing restriction level temporarily

- ① Press numeric key "4".
- ② Press the ENTER key.

To exit without changing the restriction level

Press numeric key "0".

To return to the previous menu screen

Press the RETURN key.

To exit initial setup

Select "0 Exit" in the initial setup screen.

Changing initial setup [3 Menu Language]

1 Perform steps **1** and **2** of the procedure in "Basic operation for changing the initial setup". - 41

2 Select the item to be set.

RC

1 Select an item with the cursor (Δ, ▽) keys.

2 Press the ENTER key.

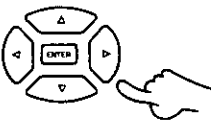

The setup completes and the initial setup screen appears again.

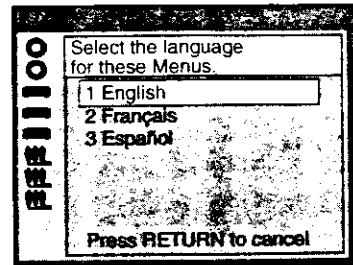

Each press of the cursor (Δ, ▽) key switches the items as follows.

- 1 1 English
- 2 2 Français
- 3 3 Español

To return to the previous menu screen

Press the RETURN key.

To exit initial setup

Select "0 Exit" in the initial setup screen.

Changing initial setup [4 On-Screen Messages]

1 Perform steps **1** and **2** of the procedure in "Basic operation for changing the initial setup". - 41

2 Select the item to be set.

RC

1 Select an item with the cursor (Δ, ▽) keys.

2 Press the ENTER key.

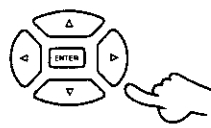

The setup completes and the initial setup screen appears again.

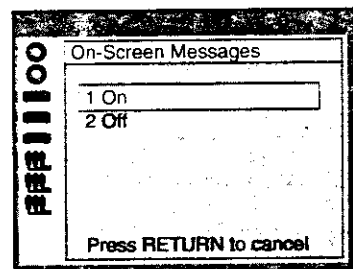

Each press of the cursor (Δ, ▽) key switches the items as follows.

- 1 1 On
- 2 2 Off

To return to the previous menu screen

Press the RETURN key.

To exit initial setup

Select "0 Exit" in the initial setup screen.

Changing initial setup [5 FL Display]

1 Perform steps **1** and **2** of the procedure in "Basic operation for changing the initial setup".

2 Select the brightness item.

RC

① Select an item with the cursor (Δ , ∇) keys.

② Press the ENTER key.

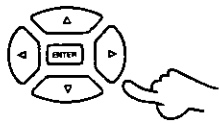

The setup completes and the initial setup screen appears again.

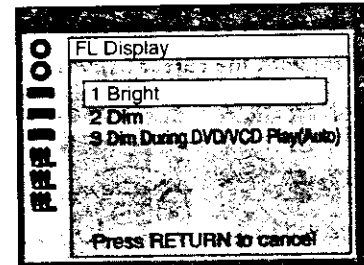

Each press of the cursor (Δ , ∇) key switches the items as follows.

- 1 1 Bright
: Sets the FL display always bright.
- 2 2 Dim
: Sets the FL display always dim.
- 3 3 Dim During DVD/VCD Play (Auto)
: Sets the FL display dim only during playback of a DVD or VCD.

- The FL display becomes temporarily bright during slow playback, forward search and reverse search.

To return to the previous menu screen

Press the RETURN key.

To exit initial setup

Select "0 Exit" in the initial setup screen.

Changing initial setup [6 TV Aspect]

1 Perform steps **1** and **2** of the procedure in "Basic operation for changing the initial setup".

2 Select the aspect ratio of your TV.

RC

- ① Select an item with the cursor (Δ, ▽) keys.
- ② Press the ENTER key.

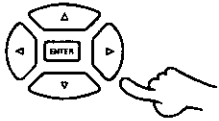

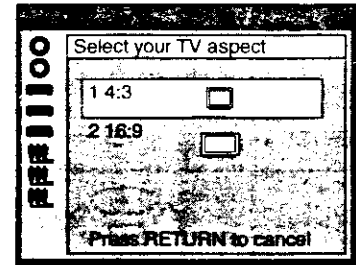

Each press of the cursor (Δ, ▽) key switches the items as follows.

- 1 4:3
- 2 16:9

Setting details

[1 4:3] (Factory setup)

Select this item when the player is connected to a TV with standard aspect ratio.

- Wide-screen software with pan & scan specification is played in a panned & scanned screen (with the left and right sides cut off).

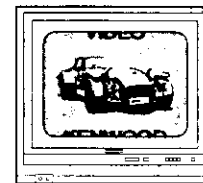

- Wide-screen software with pan & scan specification is played in a letterbox screen (with black stripes on the top and bottom).

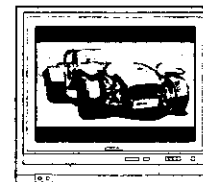

[2 16:9]

Select this item when the player is connected to a wide-screen TV. Wide-screen software is played in a full wide-screen.

- Set the picture mode of the wide-screen TV to "FULL".

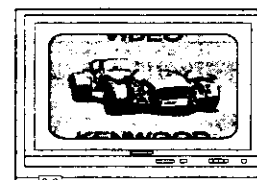

To return to the previous menu screen

Press the RETURN key.

To exit initial setup

Select "0 Exit" in the initial setup screen.

Changing initial setup [7 Digital Audio Output]

1 Perform steps **1** and **2** of the procedure in "Basic operation for changing the initial setup".

— 41

2 Select the item to be set.

RC

① Select an item with the cursor (Δ, ▽) keys.

② Press the ENTER key.

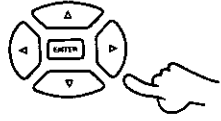
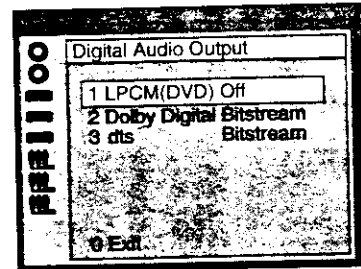
Each press of the cursor (Δ, ▽) key switches the items as follows.

- 1 1 LPCM (DVD)
 - : When playing a DVD with linear PCM recording, whether the playback signal is to be converted into a 48 kHz/16-bit signal and output at the digital audio output (optical/coaxial) or not can be selected.
- 2 2 Dolby Digital
 - : When playing a DVD with Dolby Digital (AC-3) recording, the format of the signal output from the digital audio output (optical/coaxial) can be selected (from bitstream and PCM).
- 3 3 dts
 - : Whether the digital audio output (optical/coaxial) outputs digital signal or not can be selected.
- 4 0 Exit
 - : Exits the current screen.

3 Select the desired option.

RC

① Select an item with the cursor (Δ, ▽) keys.

② Press the ENTER key.

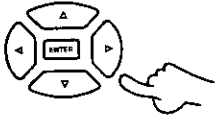

The setup completes and the initial setup screen appears again.

Setting details

When [1 LPCM (DVD)] is selected:

- 1 Off (Factory setup)
 - Only the linear PCM audio digital signal with 48 kHz/16-bit recording is output.
 - No digital signal is output during playback of a DVD with 48 kHz/20-bit or 24-bit or 96 kHz linear PCM recording.
 - 2 PCM
 - When a DVD with 48 kHz/20-bit or 24-bit or 96 kHz linear PCM recording is played, the signal is converted into a 48 kHz/16-bit signal and output at the digital outputs.
- The digital output of the PCM audio becomes a 48 kHz/16-bit or lower signal because of the consideration for the copyright.

When [2 Dolby Digital] is selected:

- 1 Bitstream (Factory setup)
 - When a DVD with Dolby Digital (AC-3) recording is played, the Dolby Digital (AC-3) bitstream (2- to 6-channel) audio is output. Select this option when a Dolby Digital (AC-3) decoder is connected to the player.
- 2 PCM
 - When a DVD with Dolby Digital (AC-3) recording is played, the signal is converted into a 48 kHz/16-bit signal and output at the digital outputs.

When [3 dts] is selected:

- 1 Off
 - The DTS output is switched off.
- 2 Bitstream (Factory setup)
 - The DTS output is switched on.

To return to the previous menu screen

Press the RETURN key.

To exit initial setup

Select "0 Exit" in the initial setup screen.

Recommended setup for [7 Digital Audio Output]

The recommended setup for [7 Digital Audio Output] is variable depending on the equipment connected to the digital audio output. Set up this item by referring to the following table.

Digital Audio Output Connection	[7 Digital Audio Output] Setup		
	1 LPCM (DVD)	2 Dolby Digital	3 dts
When no equipment is connected	Off (Factory setup)	Bitstream (Factory setup)	Off
When an amplifier having a digital input but not incorporating a Dolby Digital (AC-3) decoder is connected	PCM (*1)	PCM (*2)	Off
When a Dolby Digital (AC-3) decoder is connected	PCM (*1)	Bitstream	Off
When a Dolby Digital (AC-3) or DTS decoder is connected	PCM (*1)	Bitstream	Bitstream (*3)

(*1): The signal from the audio output of the player is converted into a 48 kHz/16-bit signal just like the signal output from the digital audio output. Therefore, if you want to play high audio quality software with 48 kHz/20-bit or 24-bit or 96 kHz recording, do not connect the equipment such as an amplifier or decoder to the digital audio output (i.e. set [1 LPCM (DVD)] to "1 Off") and connect the equipment directly to the audio output jacks.

(*2): Set to "PCM" when connecting the equipment other than a Dolby Digital (AC-3) decoder. If this item is set to "Bitstream", loud noise may be produced and speakers may be damaged.

(*3): Noise may interfere with the speaker output if the player is connected to a piece of equipment which does not incorporate an DTS decoder. Never connect the player to equipment without a built-in DTS decoder.

Changing initial setup [9 Other Settings]

1 Perform steps **1** and **2** of the procedure in "Basic operation for changing the initial setup".

41

2 Select the item to be set.

RC

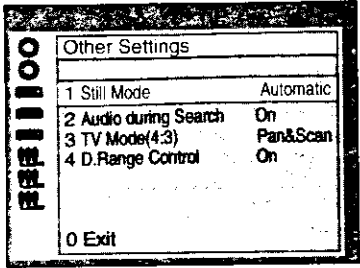

1 Select an item with the cursor (Δ , ∇) keys.

2 Press the ENTER key.

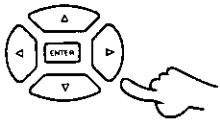

Each press of the cursor (Δ , ∇) key switches the items as follows.

- 1 **1 Still Mode**
: Reduces image blur which tends to be observed on still images.
- 2 **2 Audio During search**
: Switches the audio during forward search at the 1st speed on or off.
- 3 **3 TV Mode (4:3)**
: Sets the TV screen mode when wide-screen software is played through a standard-screen TV.
- 4 **4 D. Range Control**
: Sets the range of the audio output when a disc is played.
- 5 **0 Exit**
: Exits the current screen.

Setting details

When [1 Still Mode] is selected

- 1 **Automatic (Factory setup)**
Usually select this option, with which frame still image or field still image are switched automatically.
- 2 **Field**
Select this option when image blur is observed when this item is set to "Automatic".

When [2 Audio During Search] is selected

- 1 **On (Factory setup)**
Select this option if you want to output audio during forward search at the 1st speed.
● Select "Off" if noise during search disturbs you.
- 2 **Off**
Select this option if you want to mute audio during forward search at the 1st speed.

When [3 TV Mode (4:3)] is selected

- 1 **Pan & Scan (Factory setup)**
Select this option if you need a panned & scanned screen (which is cut on the left and right sides) when playing wide-screen software. However, even when this option is selected, software without pan & scan specification is played in a letterbox screen.
- 2 **Letterbox**
Select this option if you need a letterbox screen (which has black stripes on the top and bottom) when playing wide-screen software.

When [4 D. Range Control] is selected

- 1 **Off**
Returns to the standard setup.
- 2 **On (Factory setup)**
This option reproduces a DVD with Dolby Digital recording in a powerful sound even when the volume is low.
● This effect may not be available depending on the combination of speakers.

To return to the previous menu screen

Press the RETURN key.

To exit initial setup

Select "0 Exit" in the initial setup screen.

DVD menu language code list

Cord No.	Language
6565	Afar
6566	Abkhazian
6570	Afrikaans
6577	Amharic
6582	Arabic
6583	Assamese
6588	Aymara
6590	Azerbaijani
6665	Bashkir
6669	Byelorussian
6671	Bulgarian
6672	Bihari
6678	Bengali; Bangla
6679	Tibetan
6682	Breton
6765	Catalan
6779	Corsican
6783	Czech
6789	Welsh
6865	Danish
6869	German
6890	Bhutani
6976	Greek
6978	English
6979	Esperanto
6983	Spanish
6984	Estonian
6985	Basque
7065	Persian
7073	Finnish
7074	Fiji
7079	Faroese
7082	French
7089	Frisian
7165	Irish
7168	Scots Gaelic
7176	Galician
7178	Guarani
7185	Gujarati
7265	Hausa
7273	Hindi
7282	Croatian
7285	Hungarian
7289	Armenian
7365	Interlingua
7378	Indonesian
7383	Icelandic
7384	Italian
7387	Hebrew
7465	Japanese

Cord No.	Language
7473	Yiddish
7487	Javanese
7565	Geogian
7575	Kazakh
7576	Greenlandic
7577	Cambodian
7578	Kannada
7579	Korean
7583	Kashmiri
7585	Kurdish
7589	Kirghiz
7665	Latin
7678	Lingala
7679	Laothian
7684	Lithuanian
7686	Latvian; Lettish
7771	Malagasy
7773	Maori
7775	Macedonian
7776	Malayalam
7778	Mongolian
7779	Moldavian
7782	Marathi
7783	Malay
7784	Maltese
7789	Burmese
7865	Nauru
7869	Nepali
7876	Dutch
7879	Nowegian
7982	Oriya
8065	Punjabi
8076	Polish
8083	Pashto; Pushto
8084	Portuguese
8185	Quechua
8277	Rhaeto-Romance
8279	Romanian
8285	Russian
8365	Sanskrit
8368	Sindhi
8372	Serbo-Croatian
8373	Singhalese
8375	Slovak
8376	Slovenian
8377	Samoaian
8378	Shona
8379	Somali
8381	Albanian
8382	Serbian

Cord No.	Language
8385	Sundanese
8386	Swedish
8387	Swahili
8465	Tamil
8469	Telugu
8471	Tajik
8472	Thai
8473	Tigrinya
8475	Turkmen
8476	Tagalog
8479	Tonga
8482	Turkish
8484	Tatar
8487	Twi
8575	Ukrainian
8582	Urdu
8590	Uzbek
8673	Vietnamese
8679	Volapük
8779	Wolof
8872	Xhosa
8979	Yoruda
9072	Chinese
9085	Zulu

CD-TEXT operation

DV-203 (En/K)

When playing a CD-TEXT disc, the text information recorded in the disc (disc title, verse writer names, music composer names, etc.) can easily be recalled and displayed in alphanumeric characters.

Preparation

- 1 Load a disc (with CD-TEXT compatibility) in the player.
- 2 Start normal playback (track mode).

Software with which this function is available:



Searching for tracks by title (TITLE SEARCH)

Any track in a CD-TEXT disc can be search based on the title.

1 Press the TITLE SEARCH key in stop mode.

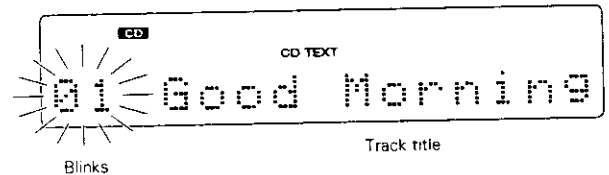
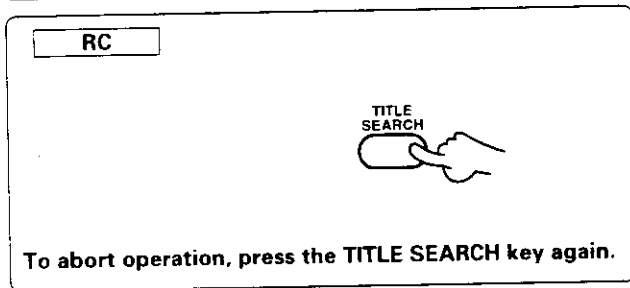

- If the current disc is not a CD-TEXT disc, "NO CD TEXT" is displayed for about 3 seconds.

2 Select the desired track title.

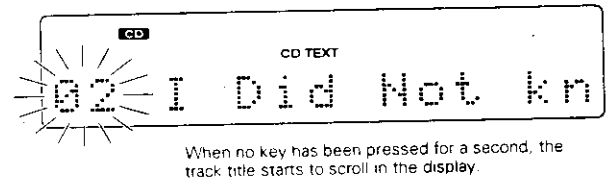
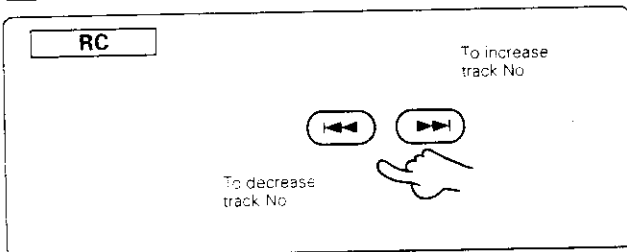

3 Start playback.

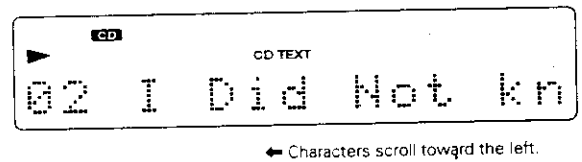
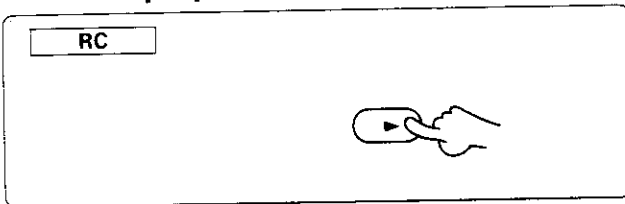

Scrolled display

When an item of character information such as a track title is too long to be accommodated in the display, the characters flow from the left to the right to show the characters which have been invisible in the beginning. This movement is referred to as the scrolled display.

Example

01 ABCDEFGHIJKLMNOPQ...

← Scrolled display

MNOPQ...

Selecting the text information display (TEXT DISPLAY)

Remote control unit only

53

In the case of a CD-TEXT disc, the displays shown below can be selected.

RC

Press the TEXT DISPLAY key.



TEXT DISPLAY

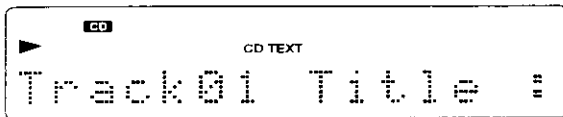

CD CD TEXT
Track01 Title :

← Scroll display

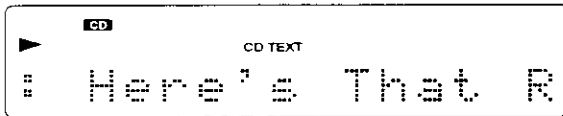

CD CD TEXT
: Here's That R

● In the case of a non-CD-TEXT disc, the "NO CD TEXT" display will appear for approx. 3 seconds.

In the stop mode

When the TEXT DISPLAY key is pressed once, the 1 "Disc Title" is scrolled on the display; when it is pressed repeatedly, the display is changed.

- 1 Disc Title : Disc title
- 2 Disc Artist : Singer (or performer)
- 3 TIME : Track No., time display

● If the key is released while 2 "Disc Artist" is displayed, 1 "Disc Title" returns to the display.

In the play mode

When the TEXT DISPLAY key is pressed once, the 1 "Track Title" is scrolled on the display; when it is pressed repeatedly, the display is changed.

- 1 Track Title : Track title
- 2 Track Artist : Singer (or performer)
- 3 Disc Title : Disc title
- 4 Disc Artist : Singer (or performer)
- 5 TIME : Track No., time display

● If the key is released at any point while 2 "Track Artist" to 4 "Disc Artist" is displayed, 1 "Track Title" returns to the display.

Displaying all the text information (ALL INFO.)

Remote control unit only

In the case of a CD-TEXT disc, the text information shown below is displayed automatically. (This does not operate during program setup.)

RC

Press the ALL INFO. key.

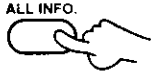

ALL INFO.

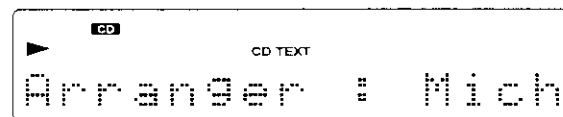

CD CD TEXT
Arranger : Mich

← Scroll display

To skip to the next track while the items are being displayed:

Press the ►► key.

- The display can be returned to a previous item by pressing the ◀◀ key.
- ALL INFO. is released when any other key is pressed while items are being displayed.

Each item is displayed in turn each time the ALL INFO. key is pressed. When the key is repeatedly pressed while an item is being displayed, the display is forcibly moved to the next item.

- 1 Disc/Track Title : Disc and track titles
- 2 Disc/Track Artist : Singer (or performer)
- 3 Disc/Track Songwriter : Songwriter
- 4 Disc/Track Composer : Composer
- 5 Disc/Track Arranger : Arranger
- 6 Disc/Track Message : Message from sponsor or artist
- 7 ID INFO. : Record company, release date, etc.
- 8 Genre INFO. : Genre information
- 9 ALL INFO. END : (Release)

● Items from 1 to 6 are displayed in the sequence of disc and track.
● In the case of a non-CD-TEXT disc, the "NO CD TEXT" display will appear for approx. 3 seconds.

Graphical remote control unit (GRC unit)

DV-203 (En/K)

The GRC unit provided with KENWOOD AUDIO VIDEO SURROUND RECEIVER (optionally available) can also remote control the DVD player. For details, please also refer to the instruction manual of your AUDIO VIDEO SURROUND RECEIVER (optional).

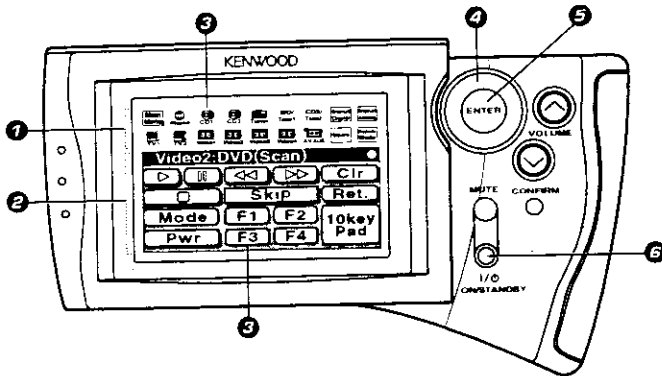

Model: RC-R0907
RC-R0807

* Remote control unit is variable depending on the area where it is marketed.

1 Segment screen

Shows the icons which are mainly used to select the controlled components

2 Menu screen

Shows the icons used to select the operation modes.

Play (▶) icon

Starts playback.

Pause (||) icon

Lets playback pause temporarily.

Search (◀◀, ▶▶) icons

Fast forwards or fast reverses a track. With a DVD, also used for frame-by-frame playback.

Clr (Clear) icon

Clears a track, screen, etc.

Stop (■) icon

Skip icons

Skips tracks, etc. when locating the beginning of a track, etc.

Ret. (Return) icon

Returns to the previous menu (or hierarchy level).

Mode icon

Selects the play mode.

Pwr (Power) icon

When the POWER switch of the player is set to ON, puts it in standby mode.

F1 to F4 icons

Any of these icons switches the screen to one of the menu screens represented by F1 to F4.

10-keypad icon

Switches the screen to the numeric icon menu screen.

3 Icons

Icons are displayed according to the controlled component and operation mode.

4 Joystick

Used to select the icons. (Can be tilted in 4 directions by pushing the peripheral circle section of the ENTER key.)

5 ENTER key

Press to set or enter the selected icon (operation mode, etc.).

6 I/O (ON / STANDBY) key

Switches the AUDIO VIDEO SURROUND RECEIVER (option) to the ON mode or STANDBY mode.

Basic operation of the DVD player

It is first necessary to assign the DVD player to the GRC unit. The DVD player control screen cannot be displayed unless it has been assigned to the GRC unit.

1 Assign the connected component (DVD player in this case) to the input selector. (Refer to the instruction manual of the AUDIO VIDEO SURROUND RECEIVER.)

2 In the segment screen, select the icon of the component to be controlled.
Example: If the DVD player has been assigned to "Video 2", select the "Video 2" icon.

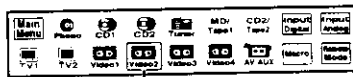

The point of the cursor

3 In the menu screen, select the icon of the desired operation.

Scan menu screen

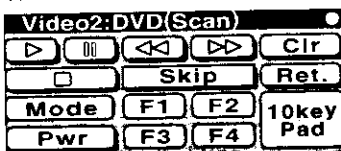

Skip menu screen

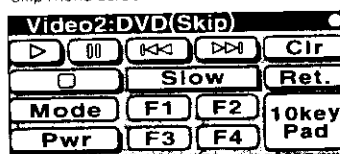

Slow menu screen

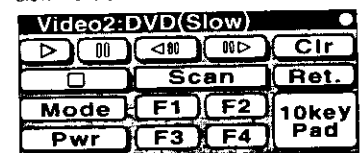

When the Skip, Slow or Scan icon is selected, the menu screen switches over to the control menu screen for the selected operation.

DVD: Digital Versatile Disc

A type of disc which contains recording of audio/video packaged media with high video and audio quality, such as a movie, featuring large recording capacity and digital signal processing capability.

VIDEO CD (VCD)

A type of CD which contains the recording of moving images. It compresses image information by about 1/120 and audio information by about 1/6 and accommodates up to 74 minutes of recording in a disc with the same diameter as ordinary music CD of 12 cm.

Some VCDs do not have the PBC compatibility and are capable of playback only, while some are PBC-compatible and are capable of various special playback control operations. This player can play both of these VCDs.

MPEG: Moving Picture Expert Group (DVD, VCD)

This is an international standard for digital video and audio compression and decompression in media.

Dolby Digital (AC-3)

This is a digital audio compression technology developed by Dolby Laboratories. It is compatible with 5.1-channel surround audio as well as normal stereo (2-channel) audio and can accommodate a large amount of audio data efficiently in a disc.

DTS

Name of a digital surround system developed by Digital Theater Systems, Inc.

GUI: Graphical User Interface

An operation method with which the user can interface the machine in an interactive manner with the help of displayed graphics.

Title menu/DVD menu (DVD)

Some DVDs display more than one title in a screen. This screen is referred to as the title menu.

The DVD menu is the item display (menu screen) for use in setting operations. The DVD menu can be recalled any time during playback to perform settings according to the current software, including the audio switching between Dolby Digital and PCM, switching of language used in the subtitles and spoken voice.

Title/title number (DVD)

The title is the largest unit of video and audio recorded in a DVD. It usually corresponds to a single movie of video software or an album (sometimes a piece of music) of music software. The numbers assigned to individual titles are referred to as the title numbers.

Chapter/chapter number (DVD)

The chapter is a section of video and audio recorded in a DVD. A title is composed of several chapters. The numbers assigned to individual chapters are referred to as the chapter numbers.

Subtitles (DVD)

Some DVD discs contains the recording of more than one subtitle language. This player allow you to select one of the recorded subtitle languages during playback. If the subtitle language is set to "Automatic" in the initial setup, subtitles are displayed only when the spoken voice is in other language than the initial set language.

Track/track number (CD, VCD)

A track is also a section of video and audio recorded in a disc. The numbers assigned to individual tracks are referred to as the track numbers.

With most of music CDs, a track is assigned to a piece of music. However, with a VCD, the sections of the contents do not always correspond to the assigned tracks.

As (special) playback functions such as skipping and programming of ordinary CDs are based on track number data, such playback functions are sometimes impossible with some VCDs.

TOC: Table Of Contents (CD, VCD)

The TOC consists of information on the number of tracks and playing time and corresponds to the table of contents of a book. In addition to audio (and video) data, all discs contain the recording of TOC data in the beginning of disc.

P.B.C.: Play-Back Control (VCD)

When a VIDEO CD carries "Play Back Control capable" or similar message on the disc or jacket, desired scenes and information can be played back in an interactive manner using a hierarchical structure while viewing the menu screens displayed on the TV screen.

Aspect ratio

This is the ratio between the horizontal and vertical sizes of the picture displayed on the TV screen. The aspect ratio of a standard-screen TV is 4:3 and that of a wide-screen or HDTV is 16:9.

Pan & scan (DVD)

A method of displaying a wide-screen picture, recorded with an aspect ratio of 16:9, on a standard, 4:3 TV screen by trimming parts of the picture. In general, the trimmed parts of a panned & scanned screen is determined according to the player component. However, the DVD discs can also record the specification by the software producer related to the trimmed positions.

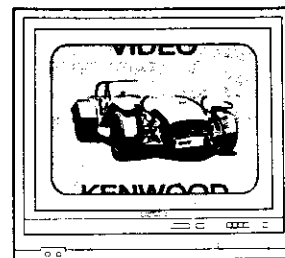
**Letterbox (DVD)**

This method of displaying a wide-screen 16:9 picture on a standard 4:3 TV screen displays a horizontally long image on the screen center and black stripes on the top and bottom of it.

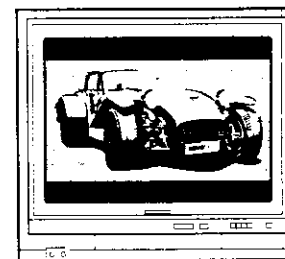
**Bitstream (DVD)**

This is the generic name representing flow of data in accordance with various standards, other than the standardized audio data.

In case of difficulty

DV-203 (En/K)

What appears to be a malfunction may not always be serious. If your unit should not perform as expected, consult the table below to see if the problem can be corrected before seeking help from your dealer or service representative.

Operation to reset

The microprocessor may fall into malfunction (impossibility to operate erroneous display, etc.) when the power cord is unplugged while power is ON or due to an external factor. In this case, execute the following procedure to reset the microprocessor and return it to normal condition.

While holding the **■** key, press and hold the **■** key until "INITIAL OK!" appears.

- Please note that resetting the microprocessor clears the contents stored in, it returns the microprocessor to the condition when it left the factory.

DVD player unit

Symptom	Cause	Remedy
Playback does not start when the play (▶) key is pressed.	<ul style="list-style-type: none"> ● There is no disc in the player. ● There are no signals recorded on the side of the disc being played. 	<ul style="list-style-type: none"> ● Load a disc and press the play (▶) key. ● Turn the disc over and properly place it on the disc tray.
Playback starts but no image/sound is seen/heard.	<ul style="list-style-type: none"> ● The TV is not turned on. ● The connection cords are not properly connected. 	<ul style="list-style-type: none"> ● Turn on the TV. ● Properly reconnect the connection cords.
The picture is disrupted when the image is fast forwarded or fast reversed.	<ul style="list-style-type: none"> ● The picture is slightly disrupted during fast forward and fast reverse operations. 	<ul style="list-style-type: none"> ● This is not a malfunction.
No sound is heard.	<ul style="list-style-type: none"> ● The audio output cords are not properly connected. ● The volume control of the TV or amplifier is not adjusted properly. ● The player is in a special playback mode. 	<ul style="list-style-type: none"> ● Properly connect the audio cords. ● Set the sound volume to an appropriate level. ● Press the play (▶) key to resume normal playback mode.
The picture does not look good or the picture/sound quality is poor.	<ul style="list-style-type: none"> ● A nearby device is generating noise. ● The disc is dirty. ● The disc is damaged. ● There is condensation on the optical lens. 	<ul style="list-style-type: none"> ● Separate this unit as far as possible from the device you think is generating the noise. ● Refer to the "Disc handling precautions" section and wipe dirt from the disc. ● Use a new disc. ● Refer to the "Beware of condensation" section and evaporate the condensation.
It takes a while for the disc to start playing.	<ul style="list-style-type: none"> ● Time is required for the unit to detect the disc type and size and for the rotation of the motor to stabilize. This is not a malfunction. 	<ul style="list-style-type: none"> ● Approximately 10 to 20 seconds are required for a disc to start playing, although the time differs depending on the disc.
The tray opens automatically.	<ul style="list-style-type: none"> ● The disc is not placed horizontally. 	<ul style="list-style-type: none"> ● Properly place the disc on the tray.
The top and bottom of the screen cannot be seen.	<ul style="list-style-type: none"> ● The video format of the disc being played does not match that of the connected TV monitor. 	<ul style="list-style-type: none"> ● Refer to the "Video formats" section, and use a disc with the appropriate video format for your TV or a TV with the appropriate video format for the disc.
A VCD cannot be played using menus.	<ul style="list-style-type: none"> ● The VCD disc being played is not compatible with P.B.C. 	<ul style="list-style-type: none"> ● Menu playback is available only with VCD discs recorded with P.B.C.
The subtitle is not displayed.	<ul style="list-style-type: none"> ● The DVD disc being played does not contain the recording of subtitles. ● The subtitle mode is set to off. 	<ul style="list-style-type: none"> ● The subtitle cannot be displayed when the DVD disc being played does not contain the recording of subtitles. ● Press the SUB TITLE key to switch on the subtitle mode.
The voice (or subtitle) language cannot be changed.	<ul style="list-style-type: none"> ● The DVD disc being played does not contain the recording of more than one audio (or subtitle) language. 	<ul style="list-style-type: none"> ● The voice (or subtitle) language cannot be changed when the DVD disc being played does not contain the recording of more than one voice (or subtitle) language.
The viewing angle cannot be changed.	<ul style="list-style-type: none"> ● The DVD disc being played does not contain the recording of more than one angle. ● You are attempting to switch the angle in a DVD section where more than one angle is not recorded. 	<ul style="list-style-type: none"> ● The viewing angle cannot be changed when the DVD disc being played does not contain the recording of more than one angle. ● More than one viewing angle may be recorded only in limited sections in a disc.

DVD player unit

Symptom	Cause	Remedy
Playback will not start even after a title is selected.	<ul style="list-style-type: none"> ● A viewing restriction (RATING) has been set for the disc. 	<ul style="list-style-type: none"> ● Check the viewing restriction level (RATING) setting.
The viewing restriction level (RATING) cannot be changed.	<ul style="list-style-type: none"> ● You have forgotten the viewing restriction (RATING) password. 	<ul style="list-style-type: none"> ● Set the initial setup to the factory setup with the following procedure. While holding the ■ key, press and hold the ■ key until "INITIAL OK!" appears.
The voice or subtitle language selected in the initial setting is not played.	<ul style="list-style-type: none"> ● The DVD disc being played does not contain the recording of the selected voice or subtitle language. 	<ul style="list-style-type: none"> ● Use a DVD disc containing the recording of the selected voice or subtitle language.
No message appears on the TV screen after a key is pressed.	<ul style="list-style-type: none"> ● The function for displaying message on the TV screen (On-Screen Messages) is set to off. 	<ul style="list-style-type: none"> ● Set On-Screen Messages to on.
Menu screen messages are not shown in the desired language.	<ul style="list-style-type: none"> ● The menu language function (MENU) is not set. 	<ul style="list-style-type: none"> ● Set the disc menu language function (MENU) as required.

Remote control unit

Symptom	Cause	Remedy
Remote control operation is not possible.	<ul style="list-style-type: none"> ● Batteries are exhausted. ● The remote control is too far away from the system, the controlling angle is deviated or there is an obstacle in between. 	<ul style="list-style-type: none"> ● Replace with new batteries. ● Operate the unit inside the remote control-able range.

Inhibition icon

Symptom	Cause	Remedy
 <p>The inhibition icon is displayed and remote control is not possible.</p>	<ul style="list-style-type: none"> ● Playback is restricted intentionally by the software producer. 	<ul style="list-style-type: none"> ● The operation is inhibited. Please try another operation.

Specifications

DV-203 (En/K)

[Type]

System DVD video player system
Signal read system Semiconductor laser

[D/A Conversion Section]

D/A conversion 24 Bit
Oversampling 8 fs (Sampling frequency; 44.1, 48 kHz)
4 fs (Sampling frequency; 96 kHz)

[Audio section]

Frequency response
Sampling frequency; 44.1 kHz (CD only) 2 Hz ~ 20 kHz
Sampling frequency; 48 kHz 2 Hz ~ 22 kHz
Sampling frequency; 96 kHz 2 Hz ~ 44 kHz
Signal to noise ratio (CD only) More than 110 dB
Dynamic range (CD only) More than 97 dB
Total harmonic distortion (CD only)
..... Less than 0.003 % (1 kHz)
Channel separation (CD only)
..... More than 90 dB (1 kHz, MIX LINE OUTPUT)
Wow and flutter (CD only)
..... Below measurable limit (± 0.001 % W. PEAK)
Analog output level/impedance
2ch 2 V_{rms} / 510 Ω
Digital output level/impedance
COAXIAL 0.5 V_{p-p} / 75 Ω
OPTICAL -21 dBm ~ -15 dBm (Wave length 660 nm)

[Video Section]

Video output format NTSC
Video compression
VCD MPEG-1
DVD MPEG-2
Composite video output level
..... 1 V_{p-p} (75 Ω load, sync. negative)
S-video output level
(Y-signal) 1 V_{p-p} (75 Ω load, sync. negative)
(C-signal)
NTSC 0.286 V_{p-p} (75 Ω)
Component video output level
Y-signal 1 V_{p-p} (75 Ω load, sync. negative)
Ca-signal ± 0.324 V_{p-p} (75 Ω) (FCC 100% Color Bar)
Cb-signal ± 0.324 V_{p-p} (75 Ω) (FCC 100% Color Bar)
Horizontal resolution More than 500 lines
Video signal to noise ratio More than 65 dB

[General]

Power consumption 35 W
Dimensions W: 440 mm (17-5/16")
H: 93 mm (3-11/16")
D: 390 mm (15-3/8")
Weight (net) 4.5 kg (9.9 lb)



KENWOOD follows a policy of continuous advancements in development. For this reason specifications may be changed without notice.

- Sufficient performance may not be exhibited at extremely cold locations (Where water freezes).

MEMO:

DV-203 (En/K)

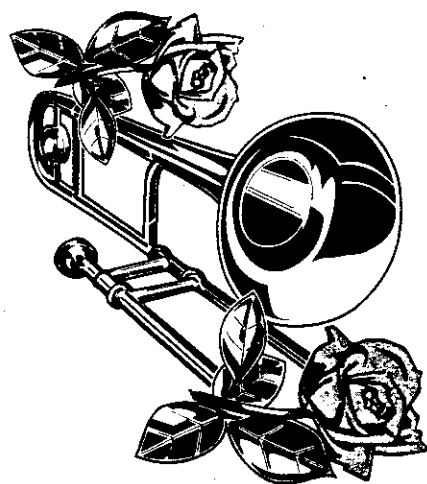

KENWOOD

For your records

Record the serial number, found on the back of the unit, in the spaces designated on the warranty card, and in the space provided below. Refer to the model and serial numbers whenever you call upon your dealer for information or service on this product.

Model _____ Serial Number _____